



Statens vegvesen

Vehicle Restraint Systems and Roadside Areas

Specifications

Manual 231 E

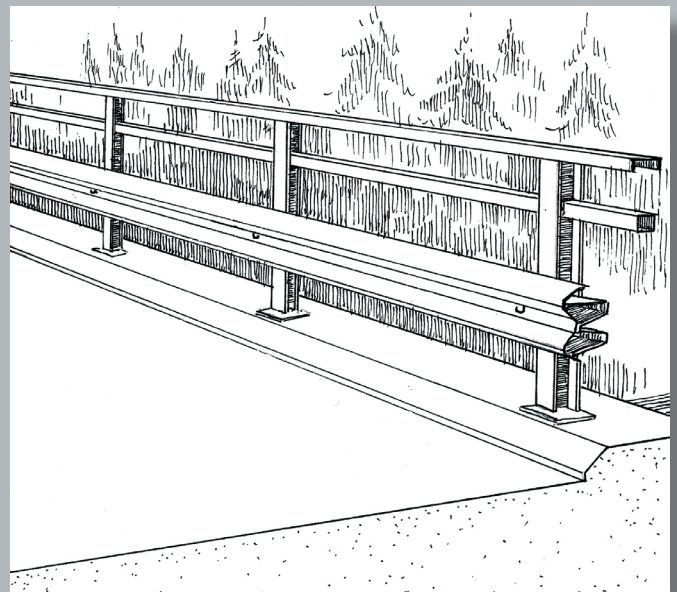
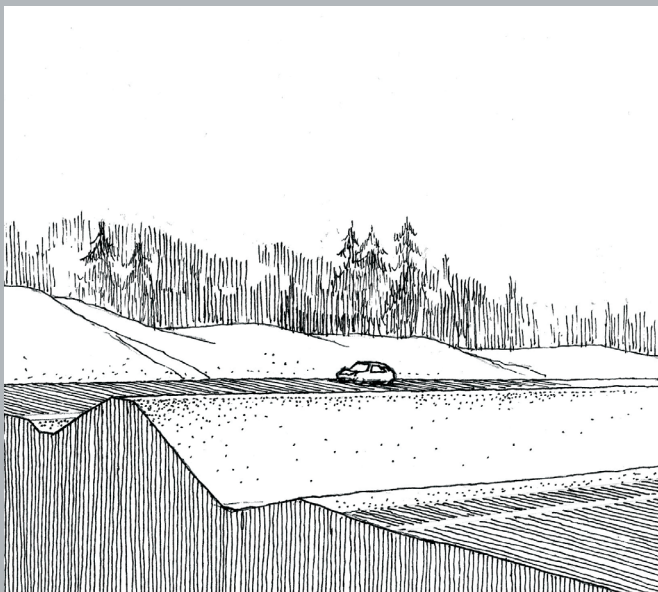
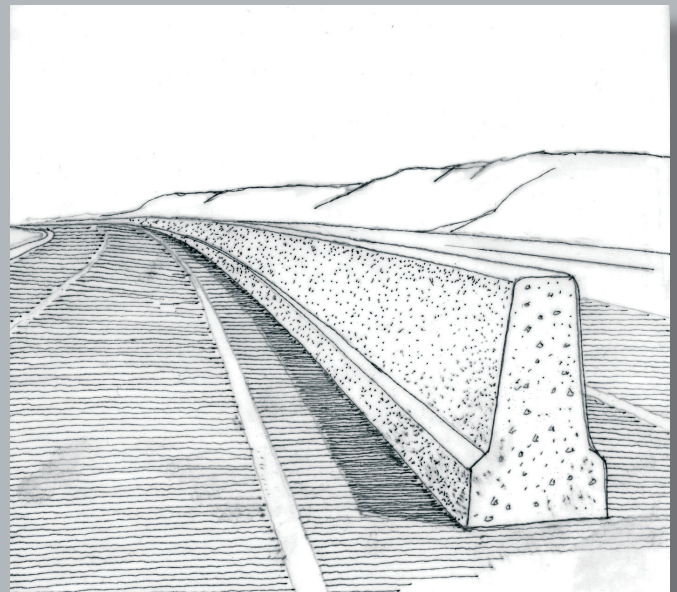
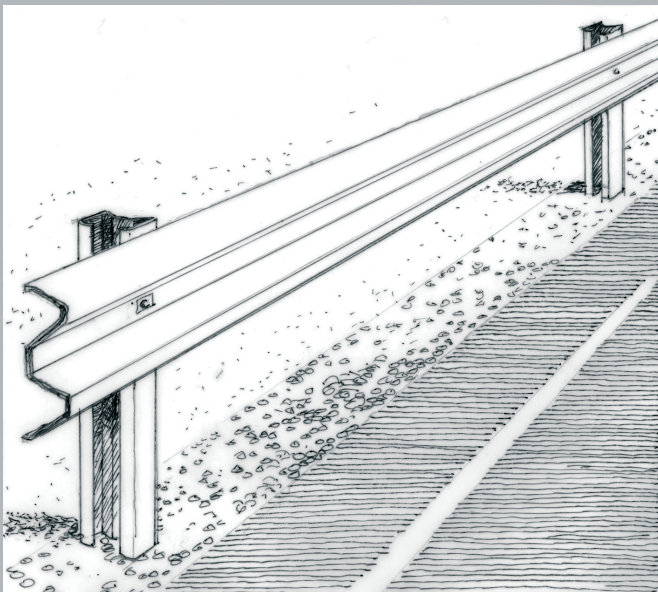

Manual 231 E

Vehicle Restraint Systems

and Roadside Areas

December 2011

Norwegian Public Roads Administration Manuals

This is a Level 1 Manual (Guidelines) in the Norwegian Public Roads Administration's series of manuals, a collection of consecutively numbered publications intended first and foremost for use within the NPRA.

The Norwegian Directorate of Public Roads has the primary responsibility for compiling and updating the manuals.

The Norwegian Public Roads Administration's Graphics Centre is responsible for graphic design and production.

The online version of the manual can be found at www.vegvesen.no

The Roads Administration publishes two categories of manuals:

Category 1 – Yellow stripe on the cover – comprises regulations, specifications and guidelines approved by a higher authority or by the Directorate of Public Roads according to authorisation.

Category 2 – Blue stripe on the cover – comprises guidelines, textbooks and roads data approved by the department authorised to do so by the Directorate of Public Roads.

Vehicle Restraint Systems – and Roadside Areas

No. 231 of the Norwegian Public Roads Administration's series of manuals

ISBN: 978-82-7207-652-7

Foreword

This Vehicle Restraint Systems and roadside areas standard is prepared under the provisions of the Ministry of Transport and Communication's regulations pursuant to Section 13 of the Public Roads Act. The regulations provide a general framework for the design and standard of roads, and apply to all public roads.

The Vehicle Restraint Systems standard contains general guidelines for the selection and installation of vehicle restraint systems. It addresses everything from road safety barriers, bridge parapets, crash cushions, terminals and the transitions between two vehicle restraint systems and guardrails for pedestrians; furthermore earth bank design is addressed as a safety barrier replacement.

This revised vehicle restraint systems standard replaces the 2003 standard and replaces the Vehicle Restraint Systems sections in other standards issued by the Norwegian Public Roads Administration.

Two guides have been prepared to describe standard vehicle restraint systems: Manual 267 Standard road safety barriers (*Standard vegrekkverk*) and Manual 268 Standard bridge parapets (*Standard brurekkverk*). These manuals describe in detail the Norwegian Public Roads Administration's standard road safety barriers and standard bridge parapets, as well as how these shall be erected. Detailed descriptions of other types of approved safety barriers and erection instructions are prepared by the individual safety barriers manufacturers.

The revision of this standard incorporates changes resulting from new experience, new knowledge and the transfer of information to and from supervisors. Additionally, there has been an express wish that all requirements regarding vehicle restraint systems should be coordinated and made available in a single publication. There has also been a desire to push the vehicle restraint system requirements even more in the direction of Vision Zero for traffic safety. This has been done in this edition.

To provide a basis for later revisions, we would like experience and information that pertains to this standard to be sent to the Directorate of Public Roads, at e-mail: Hb231@vegvesen.no.

The Directorate of Public Roads,
December 2011

Responsible unit: Bridge Section
Traffic Safety, Environment and Technology Division

Content

1	General	9
1.1	Introduction	9
1.2	Alternative solutions to safety barriers and crash cushions	9
1.3	Purpose of safety barriers and crash cushions	10
1.4	Scope of application	11
1.5	Authority to waive requirements	11
1.6	Testing and approval of safety barriers and crash cushions	12
1.7	Definitions	14
1.8	Designations	22
1.9	Speed limits/speed levels as a basis for design	23
2	Calculations for safety zones and the need for safety barriers	25
2.1	General	25
2.1.1	Requirements for documentation of road equipment	26
2.2	Safety zone width, S	27
2.2.1	Safety distance, A	28
2.2.2	Addition for sharp curves, T_1	29
2.2.3	Addition for embankments/falling gradient, T_2	30
2.2.4	Addition for slopes/ rising gradient, T_2	31
2.2.5	Addition for roadway, footway or cycle track underpass, T_3	32
2.2.6	Addition for railways, metro lines etc., T_3	32
2.2.7	Addition for areas where people congregate, T_4	32
2.2.8	Addition for special installations, T_4	33
2.2.9	Addition for medians, T_5	33
2.2.10	Overhead clearance in the safety zone	33
2.3	The need for safety barriers on embankments	34
2.4	The need for safety barriers at road cuttings, deep ditches etc.	36
2.5	The need for safety barriers at rock cuttings	37
2.6	The need for safety barriers or crash cushions by hazardous roadside obstacles	38
2.7	The need for safety barriers at medians	39
2.7.1	Emergency and maintenance openings in medians	40
2.7.2	Erected Earth embankments as medians	41
2.8	The need for safety barriers by rivers, lakes and other water	41
2.9	The need for safety barriers on bridges, retaining walls and at precipices	42
2.10	Requirements for minimum distances for safety barriers	42
2.10.1	Minimum distances between safety barriers on roads with median safety barriers	42
2.10.2	Minimum gap between safety barriers in the longitudinal direction	42
2.10.3	Minimum distance between the carriageway edge and the safety barriers	42

2.11	Protecting other road users etc.	43
2.11.1	Foot paths and cycle tracks along a road	43
2.11.2	Parallel roads	43
2.11.3	Railway and metro lines etc.	43
2.11.4	Areas where people congregate etc.	43
2.11.5	Safety barriers for worksites on roads	43
3	Criteria for selection of safety barriers	45
3.1	Basic performance requirements	45
3.2	Selection of safety barrier type	45
3.2.1	General	45
3.2.2	Containment classes	45
3.2.3	Dynamic deflection and working width	47
3.2.4	Impact severity	49
3.2.5	Aesthetics	49
3.2.6	The environment	50
3.2.7	Maintenance of safety barriers	50
3.3	Road safety barriers	50
3.3.1	General	50
3.3.2	Safety barrier requirements	51
3.3.3	Earth banks as a safety barrier replacement	51
3.3.4	Safety barriers along railways	51
3.3.5	Special regulations for certain types of safety barriers	52
3.4	Safety barriers and parapets on bridges, retaining walls and at precipices	52
3.4.1	General	52
3.4.2	Bridge parapet requirements	53
3.4.3	Geometrical bridge parapet requirements – outer parapets	55
3.4.4	Bridge parapet strength requirements	57
3.4.5	Strength requirements for the parapet’s underlying structure	58
3.4.6	Loads on expansion joints	59
3.5	Safety barriers in Tunnel	59
3.5.1	Tunnel portal safety barriers	59
3.6	Safety barriers and snowdrifts	60
3.7	Safety barriers for pedestrians and cyclists	60
3.7.1	The need for safety barriers for pedestrians and cyclists	60
3.7.2	Geometry and strength requirements for safety barriers for pedestrians and cyclists	61
3.7.3	Traffic divides between roadways and footpaths/cycle tracks	62
3.7.4	Protection of vulnerable road users	63
3.8	Protection of motorcyclists	63

4	Safety barrier lengths and terminals	65
4.1	General	65
4.2	Calculating safety barrier lengths	65
4.3	Safety barrier terminals	67
4.3.1	General	67
4.3.2	Outward curving and anchoring into the roadside terrain	68
4.3.3	Tapered terminals and safety barrier anchoring	69
4.3.4	Safety barrier terminals at road junctions	70
4.4	Energy absorbing terminals	70
4.4.1	General	70
4.4.2	Selection of energy absorbing terminals	70
4.5	Transitions between different types of safety barriers	71
4.5.1	General	71
4.5.2	Transitions between safety barriers of different stiffness classes	71
4.5.3	Transitions between safety barriers with different profiles	72
4.5.4	Transitions between safety barriers and crash cushions	72
4.6	Positioning of safety barriers in the road's cross-section	72
4.6.1	General	72
4.6.2	Positioning in the road's cross-section	72
4.6.3	Safety barriers placed on slopes	73
4.6.4	Safety barriers and kerbstones	73
4.6.5	Sideways shifting of safety barriers at roadside obstacles	73
4.6.6	Snow clearance and the positioning of safety barriers	74
5	Materials and design	75
5.1	General	75
5.2	Materials and execution	75
5.2.1	Materials and execution	76
5.2.2	Steel work	76
5.2.3	Concrete work	76
5.2.4	Plastic material	76
5.2.5	Wood material	76
5.2.6	The ground	76
5.3	Marking safety barrier components	77
6	Crash Cushions	79
6.1	General	79
6.2	Selection of crash cushions	79
6.3	Performance levels for crash cushion	80

6.4	Redirective and non-redirective crash cushions	80
6.5	Vehicle redirection classes (Z)	80
6.6	Permanent lateral displacement classes (D1-D8)	81
6.7	Impact severity	81

Appendix 1 83

A.1.1	Containment classes	83
A.1.2	The test vehicle's trajectory after an impact	84
A.1.3	Severity of impact	84

Appendix 2 87

A.2.1	Calculating safety barrier requirements on embankments/downward sloping terrain	87
A.2.2	Calculating safety barrier requirements in front of hazardous roadside obstacles.....	90

1 General

1.1 Introduction

This manual is based on the rules and regulations that the Construction Products Directive (86/106/EØF) gives. This entails that it has been harmonised with the common European guidelines for testing and approval of vehicle restraint systems – NS EN 1317, which was prepared under the auspices of CEN (Comité Européen de Normalisation) and set by Norwegian Standard, see section 1.6.

To supplement this handbook, guides have been prepared that describe standard road safety barriers in detail, including installation procedures, terminals, transitions, standard bridge parapets, guardrails for pedestrians and cyclists, crash cushions and overview lists for vehicle restraint systems, lighting columns and sign posts for use by the Norwegian Public Roads Administration.

The purpose of the handbook is to provide regulations for the design and installation of vehicle restraint systems on public roads in order to reduce the number of incidents and limit the extent of damage and injury when incidents occur. Earth embankments are also addressed as an alternative solution to vehicle restraint systems. In addition to traffic safety, an assessment is provided of environmental aspects, maintenance-friendliness, and the overall economics.

The vehicle restraint systems standard is anchored in the Vision Zero goal of significantly reducing road traffic fatalities and serious casualties in road traffic.

1.2 Alternative solutions to safety barriers and crash cushions

Unfortunate collisions with hazards along the road such as fixed obstacles and high, steep cut slopes, bridges and underpasses, can cause great personal injury. Road users must therefore be protected against such hazards. There are four ways of doing this:

1. Remove the hazards
2. Make the hazards safe (e.g. by changing the design of the median and verges of the road)
3. Replace the hazards with a passive safestructure (e.g. posts and columns)
4. Protect against hazards by installing safety barriers and/or crash cushions to prevent collision or driving off the road

There should preferably be no roadside hazards along the road. Vehicle restraint systems represent a hazard in themselves and should therefore only be installed if it is more dangerous to drive off the road than to drive into the vehicle restraint systems. Alternative solutions must therefore always be considered before a decision is made to install vehicle restraint systems. Alternative solutions to vehicle restraint systems could be:

- Fill in the terrain on the side of the road to avoid high, steep road banks
- Level fill and round off the tops and bottoms of embankments and cut slopes
- Expanding road cuttings and placing rounded embankments against the road cuttings

- Blast road cuttings to obtain the most even surface possible.
- Use closed ditches
- Use collision-safe noise barriers
- Use earth mounds or catchment ditches instead of safety barriers
- Remove or move hazards
- Use passive safe lighting columns, sign posts etc.
- Use foot path and cycle track delineations of adequate width
- Move the road alignment

Crash cushions are installed in front of obstacles on the side of the road in places where safety barriers cannot solve the problem. However driving into crash cushions may also cause personal injury. An assessment must therefore be made of whether the roadside obstacle can be removed, moved or replaced. If it can be replaced, the replacement must be done in accordance with the latest passive safety's criteria.

Dangerous road equipment such as lighting columns, sign posts etc. ought, if possible, to be replaced with equivalent passive safe types (requirements in accordance with EN 12767) instead of installing safety barriers.

If alternative measures are difficult to carry out, or will be significantly more expensive, road equipment such as safety barriers or crash cushions shall be installed if this is in agreement with the outcome of a risk analysis carried out in accordance with this standard. (See also section 2.2.)

1.3 Purpose of safety barriers and crash cushions

The purpose of safety barriers and crash cushions is primarily to reduce as much as possible the extent of damage and injuries in case of incidents where vehicles leave the road. Safety barriers and crash cushions are installed to:

- Prevent collision with dangerous obstacles in the verge
- Prevent driving off the road where there are high, steep embankments, deep ditches, water etc.
- Prevent collisions between traffic in opposite directions
- Protect road users and others who are on or near the road against vehicles
- Protect special installations near the road, e.g. railways, fuel tanks etc. against errant vehicles
- Prevent damage to road structures which could give rise to very serious consequential damage if impacted, e.g. bridges
- Prevent errant vehicles from falling down onto roads, railways or into rivers passing under the road

Safety fences shall ensure that if the beam is hit by a vehicle, the vehicle will be led along the safety fence until it stops, or it is redirected back onto the carriageway, but no further than necessary to avoid colliding with oncoming vehicles.

The end terminal of a safety fence shall ensure that the vehicle is redirected into the carriageway or drives through the termination and gradually stops without significant injury to the driver or the passengers.

A crash cushion shall either slow the vehicle down gradually to a controlled stop, or redirect the vehicle beyond the obstacle. Today crash cushions are not designed for impacts by heavy goods vehicles.

1.4 Scope of application

The collective term “road standards” encompasses both standards based on the Norwegian Public Roads Act and standards based on the Norwegian Road Traffic Act/Regulations concerning signs.

This manual deals with road standards based on the Norwegian Public Roads Act.

This vehicle restraint systems standard is based on section 13 of the Norwegian Public Roads Act and applies to all public roads, including bridges and tunnels, and facilities for pedestrians and cyclists.

The vehicle restraint systems standard comprises all types of such systems on public roads, but not pedestrian railings. It provides guidelines for the use and selection of vehicle restraint systems in connection with the planning of roads and streets. It shall be used in all types of road and street projects, for both new facilities and upgrades. It should be followed in connection with major upgrades of existing roads, but is intended for guidance only in connection with minor upgrades of existing roads. Manual 111 Operation and maintenance standard (*Standard for drift og vedlikehold*) provides minimum requirements with respect to the upgrade of existing vehicle restraint systems. The use of pedestrian railings and AADT limits for median safety barriers are addressed in Manual 017 Road and street design (*Veg og gateutforming*).

Where there is conflict between provisions, this vehicle restraint systems standard shall take precedence to the provisions of other standards with respect to vehicle restraint systems or alternative structures that replace such systems, such as earth embankments.

1.5 Authority to waive requirements

The road standards have two levels of requirements – ‘shall’ and ‘ought’ – where ‘shall’ requirements are the most important. This distinction has been made to engage superior authorities in the most important cases. Table 01 indicates the significance of the verbs ‘shall’, ‘ought’ and ‘can’, and who has the authority to waive the technical requirements for national roads.

The Norwegian Public Roads Administration can waive road standards for national roads. For county and municipal roads, this authority rests with the county administrator and the municipality, respectively.

Applications for waving of requirements are made on forms for the purpose. The forms and instructions are found at www.vegvesen.no/Fag/Vegnormaler/Fravik.

Before the appropriate authority agrees to waive the requirements, a safety assessment shall be conducted in writing.

Verb	Significance	Authority to waive requirements for national roads
Shall	Requirement	Requirements waived by the Directorate of Public Roads. Only reasoned applications shall be considered.
Ought	Requirement	The regional road office can waive the requirements. Applications must be reasoned, and the Directorate of Public Roads shall be notified and given an opportunity to oppose the dispensation within 3 weeks (6 weeks in the period from 1 June to 31 August).
Can	Recommendation	Can be waived following a professional analysis without any special requirements regarding approval procedures. The regional road manager must be informed.

Table 01: Use of shall, ought and can. Authority to waive the requirements for national roads issued in this road standard

1.6 Testing and approval of safety barriers and crash cushions

All types of vehicle restraint systems that are to be placed along public roads shall comply with the requirements of this standard.

The Directorate of Public Roads compiles a list with an overview of vehicle restraint systems for use on county and national roads in Norway. The list of test results (containment class, dynamic deflection (D/Dn), working width (W/Wn) values and classes, and impact severity level) and installation requirements for recommended safety barriers, crash cushions and terminals is published by the Directorate of Public Roads. The list is called 'Vehicle restraint systems for use on county and national roads in Norway' (*Rekkoeverk til bruk på fylkes- og riksveger i Norge*) and is posted on our website: www.vegvesen.no. A product will not be placed on the list of vehicle restraint systems for use on county and national roads in Norway before the necessary documents have been sent to the Directorate of Public Roads (this includes as a minimum requirement: test reports, drawings and product and installation descriptions).

To be placed on the list of vehicle restraint systems for use on county and national roads in Norway, the safety barriers, including transitions and terminals, bridge parapets and crash cushions shall be successfully tested in accordance with the requirements in NS EN 1317, and the requirements set out in this standard. Any non-statutory part of the EN standard will be made applicable on the same level as the other parts except that other equivalent test procedures as well as complete and documentable simulations will be accepted. The Directorate of Public Roads decides what other test procedures and simulations can be accepted.

Extra equipment mounted on vehicle restraint systems, e.g. additional rails, low level beams, post protectors, anti-dazzle screens, signposts, noise barriers etc., shall not affect the performance of the system or represent a danger to road users. If such extra equipment is assumed to be able to affect the primary function of a system, the vehicle restraint system shall be tested/analysed with

the extra equipment in place. No significant parts of the extra equipment or any other component of the vehicle restraint system, should become detached and be thrown out into the road or in any other way represent a danger for other road users (see also section 3.1). All changes to equipment on the existing vehicle restraint systems list for use on county and national roads in Norway shall be subject to the Directorate of Public Roads' approval.

The contractor that delivers safety barriers, transitions, terminals and crash cushions to the Norwegian Public Roads Administration, shall ensure that these have been approved in advance by a duly authorised body/the Directorate of Public Roads.

Off-the-shelf or custom-made vehicle restraint systems

Usually, off-the-shelf vehicle restraint systems shall be used on roads. Exceptions are subject to the Directorate of Public Roads' approval. Custom-made vehicle restraint systems are used where there is a need for specially built systems and/or no commercially available products can be found. In this context, vehicle restraint systems cannot simultaneously be an off-the-shelf product and a custom-made solution.

Vehicle restraint systems are **off-the-shelf products** when they are manufactured in factories and are commercially available. Off-the-shelf vehicle restraint systems shall comply with NS-EN 1317, which is a product standard. The tests described are a basis for conformity approval. The manufacturer/supplier is responsible for delivering the product and erecting it as it was originally tested and/or recommended by the Directorate of Public Roads.

Vehicle restraint systems are **custom-made structures** when they are specially built for the bridge concerned, built on site and/or form an integrated part of a structure. They will be included in one of the following categories:

- Built on site (e.g. onsite cast in-situ concrete barriers)
- Part of the load-bearing structure of a bridge
- Fabricated especially for the bridge concerned (e.g. in the case of special anchorage requirements or special requirements regarding the architectural design of a bridge, including vehicle restraint systems) if approved commercial products cannot be used
- Guardrails for pedestrians and cyclists

Custom-made vehicle restraint systems shall comply with NS EN 1990-1999. These systems must in principle be equally secure as those that comply with NS EN 1317; however documentation other than that for full-scale testing can be used, for example simulation tests. Programs that, from experience, give good results in relation to full-scale tests shall be used. Simulation tests are to be documented in compliance with the requirements in NS EN 1317. In addition, it must be documented that simulations of similar vehicle restraint systems have been verified with full-scale tests. Those who perform the simulations must document experience in the use of the program. The documentation shall, in as far as possible, follow the rules that the individual performance standards draw up. The documentation shall be approved by the Directorate of Public Roads.

Footway and cycle path guardrails shall comply with the load-bearing requirements given in section 3.7. They are defined as custom-made structures, as described above in this section.

Strength requirements for urban bridge parapets vary from the test requirements in NS EN 1317. Parapets for urban bridges must be tested with vehicles that are 1500 kg in weight at 60 km/h at an angle of 20° towards the parapet. The test can be performed either as a full-scale test or as a simulation. The test must show that the parapet is capable of containing and safely redirecting the vehicle, and shall be approved by the Directorate of Public Roads.

Safety barriers intended for mountainous areas must tolerate vertical and horizontal snow loads and strains resulting from snow clearance equipment.

1.7 Definitions

Terms	Definitions
Anchoring width	The width between the back edge of the safety fence post and the foot of the slope (see Figure 1.2) which is required to provide adequate anchoring for the safety fence posts (must not be confused with the safety fence's working width (W) or the available displacement space (U) behind the system.
Anchoring	Fastening of the vehicle restraint system to the road edge, the road bank or a rigid structure beside the road such as a rock cutting wall or similar. Anchoring shall preferably be done according to the manufacturer's instructions.
Annual average daily traffic (AADT)	The total number of vehicles that pass a section of road over the course of one year, divided by 365. The current AADT is used for existing roads and AADT estimates for new roads.
Back rail	Additional beam that reinforces the safety fence. It is usually placed behind the safety fence beam, where it can also function as a block-out (see Figure 1.1)
Block-out	A device that can be fitted between the safety fence beam and posts to create a greater distance between the beam and the stiff posts (see Fig1.1).
Bridge parapets	Safety barriers mounted on bridges, culverts or retaining walls on the verge of the road, where requirements for working width (W) are as for a bridge (See Figure 1.3).
Carriageway	Part of the road that is meant for normal driving. (See Figure 1.2).
Carriageway edge	Centre of the edge line that shows the transition between the carriageway and the shoulder.
Compliance approval	An approval that the product, in this case vehicle restraint systems, complies with the standard (NS EN1317) requirements.
Cover	Uncompacted material over culvert ceilings.

Crash cushion	An energy absorbing safety structure which decelerates a vehicle over a short distance in front or side collisions, or which redirects it past a hazard.
Dangerous roadside obstacles	Buildings, walls, rock cuttings, large rocks, posts, sign gantries, trees etc. adjacent to the road that could cause serious personal injury on collision.
Deformable safety barriers	Safety barriers that will sustain permanent deformation in an impact. The impact energy is partly absorbed as deformation of the safety barrier, and partly as deformation of the vehicle.
Deformation space	Distance from the inner edge of the safety fence beam to the outer edge of the bridge..
Displacement space (U)	Distance available for the safety barrier's dynamic deformation between the back edge of the safety barrier before impact, and a hazard such as the top of an embankment or a roadside obstacle (see Figure 1.5).
Distance to Hazard (L)	The distance from the edge of the carriageway (from the middle of the edge line) to the hazard. The hazard can be a dangerous roadside obstacle or a dangerous embankment, precipice, river/lake, bridge pier, culvert opening, railway etc.
Double-sided safety barrier	Safety barriers built to perform in impacts from both sides (e.g. steel safety fences with a steel beam on each side of the post). Can be used for medians on multi-lane roads.
Dynamic deflection	Cf. NS EN 1317-2. The safety barrier's maximum dynamic deformation on impact, measured as the distance between its front face before collision and its front face during collision (see Figure 1.5). Normalised Dynamic Deflection (Dn) is calculated based on the measured dynamic deflection (Dm), and other test data (speed, vehicle weight, angle). In this manual, dynamic deflection refers to Normalised dynamic deflection (Dn) unless otherwise specified.
Edge beam	Elevated edge along the side of a bridge (see Figure 1.3).
Edge line	Line that indicates the carriageway's outer edge.
Embankment foot	The location where the fill meets the original terrain (see Figure 1.2).
Embankment height (Hf)	The difference in height between the road edge and the embankment foot.
Energy absorbing terminal	End section especially installed and designed to reduce the danger of injury in case of collision with the end of the safety barrier.
Expansion joint	Term for joints between components on bridges, that are built to absorb movement due to changes in temperature, shrinkage etc. These are always used for bridge joints.
Fill	Road embankment placed over the original terrain (see Figure 1.2).

Helningsgrad	Forholdet mellom en vegskrånings høyde (målt vertikalt) og dens utstrekning (målt horisontalt – se Figur 1.2).
Footways/cycle tracks	Pathways that are designated by public signage as reserved for pedestrians, cyclists or a combination of the two types of traffic. The pathway is separated from the road by means of a grassy area, a ditch, a fence, kerbs or in another way.
Gradient	The relationship between a slope's height (measured vertically) and its length (measured horizontally) (see Figure 1.2).
Guardrails for pedestrians or cyclists	Guardrails that are only used for footways and cycle tracks and on bridges for pedestrians and cyclists. These guardrails are not made to resist collisions with motor vehicles.
Handrail	Top component of steel/concrete safety barriers; its primary function is to provide extra safety for pedestrians and cyclists. The handrail must also be able to absorb loads and transfer these to the barrier posts (see Figure 1.3).
High-speed rail	Railway with speeds up to 250 km/h.
Innersafety barrier	Bridge parapets that are used within the bridge's outer edges with traffic on one or both sides (see Figure 1.3). Inner guardrails may be used as: <ul style="list-style-type: none"> • Safety barrier between carriageways. • Safety barrier between carriageway and Footways/cycle track. • Safety barriers between carriageway and safety space on bridges (see "safety space definition").
Joint	Joint between parapets or parapet components on bridges that are not built to absorb movement from temperatures, shrinkage etc. The joint may be installed with a certain amount of slack for easier assembly and in order to limit the tensile force that can arise in components in case of buckling.
Kerb	Stones set to delineate traffic islands, pavements, medians etc. The usual materials used are granite or concrete.
Kerbs, containment	Kerbstones used for pavements or other areas that should be protected against vehicular traffic.
Kerbs, dropped	Kerbstones that may be driven over. The kerbstone is formed with a sloped edge so that the danger of damage to the vehicle and other traffic on the road is very small. Normal slopes are 1:2 or less.
Kerbs, upright	Kerbs that are not meant to be driven over. The kerbstone is formed with a straight or almost straight edge (3:1-5:1) towards the carriageway.
Median	Area that separates opposing lanes of traffic.
Median safety barriers	Safety barriers that separate carriageways with traffic in opposite directions.

Motorway	Type of road designed exclusively for motor vehicles, without direct access to properties along the road and with flyover junctions. Specified in more detail in the Traffic Regulations.
Noise barrier	A structure of wood or concrete that breaks the straight line between the source of the noise and the recipient of the noise, and which absorbs sound waves.
Noise embankment	An elevated formation in the terrain that breaks the straight line between the source of the noise and the recipient of the noise, and which absorbs sound waves.
Notified body	An institution, founded on the Construction Products Directive, which is responsible for the inspection of products to ensure they comply with the associated harmonised product standards.
Obstacle	Object that is found on or near the carriageway.
Ordinary railways	Railway with speeds of up to 200 km/h, including the metro and trams that have separate traffic space.
Outer parapet	Bridge parapet that is installed on the outer edge of the bridge (see Figure 1.3).
Overhead clearance	Lowest vertical distance between the carriageway and any obstruction above it.
Panel	Component in steel safety fences that is placed between the posts, for example slats, snow removal barriers or similar. (See Figure 1.3)
Parapet wall height	Height from the top of the lowest foothold rail to the top of the handrail on a bridge parapet.
Passive safe support	Signposts and lighting columns etc. that are tested and approved according to NS EN 12767. Products that are not tested and approved according to NS EN 12767 will not be designated passive safe, except products that are so weak and/or light in construction/design that they are inherently passive safe.
Pavement	An area for pedestrians that is separated from the carriageway by kerbstones.
Pedestrian railing	Fence that separates pedestrian traffic from motor vehicle traffic.
Parapet space on bridges	For parapets on bridges, the following special definitions apply for construction purposes (see Figure 1.3): <ul style="list-style-type: none"> • For outer parapets, the parapet space is defined as the distance from the parapet's boundary with traffic to the outer edge of the bridge. • For inner safety fences, the space is defined as the safety fence's width, including posts, and inclusive of any edge beams.
Physical median	An area that divides traffic in opposite directions and that is not part of the carriageway. The area may have safety barriers or an elevated median with kerbstones. The area may be planted, or paved with gravel or asphalt (see Figure 1.2).

Precipice	Terrain with a gradient steeper than 1:1.5.
Ramped end	Termination of a safety barrier with a gradual change in height from full height to zero.
Rigid safety barriers	Safety barriers that do not suffer large permanent deformation on impact. The impact energy is partly absorbed as deformation of the vehicle and as friction between the vehicle and the safety barrier, and in some cases by lifting the vehicle up in a controlled manner.
Risk of injury or damage	Definition, see 3.4.2.
Road cut height (Hs)	Difference in height from the edge of the shoulder to the top of the cut slope (see Figure 1.2).
Road Cuttings	Excavation in the original terrain limited by the road cutting slope and the road formation level.
Road edge	Outer edge of a road shoulder (see Figure 1.2). (May also be a cutting line between the outer edge of a shoulder, pavement, wall, building etc.)
Road type	Division of the road network into different types, depending on the function of the road.
Safety barrier	A device that shall prevent vehicles from leaving the road.
Safety barrier terminal	A special structure at the beginning or end of a safety barrier. It must be designed and assembled so that there will be the least possible danger of serious personal injury on collision.
Safety barrier width (B)	The distance between the front and back edges of the safety barriers (including beams and posts – e 1.Figure 1.1)
Safety fence beam	Longitudinal safety fence component that guides the vehicle, absorbs loads and transfers them to the fence posts/anchors re 1.Figure 1.ure 1.Figure 1.3). The term guide rail may also be used.

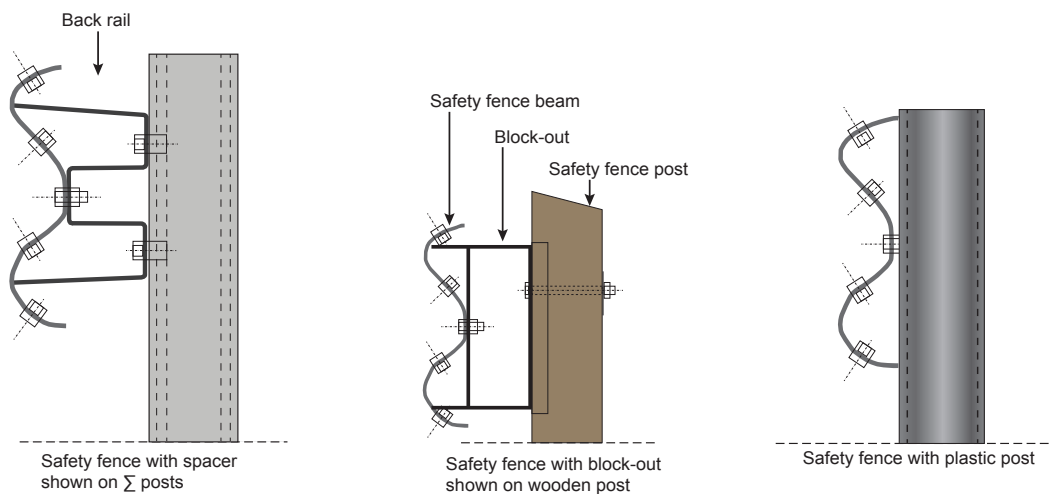

Figure 1.1 Components for standard steel rail safety fences.

Safety fence posts	Safety fence components that support the safety fence beam(s) and transfers loads from this down to the body of the road or the bridge deck (Figure 1.1, Figure 1.3).
Safety space	The area outside the carriageway on bridges that is not intended for pedestrian/bicycle traffic, but which serves as an area where people can pull over for maintenance/emergency stop (Figure 1.3). The area is secured with safety barriers on both sides.
Safety zone	An area outside the carriageway where there shall be no hazards such as dangerous roadside obstacles, dangerous slopes or similar. Within the safety zone, hazards shall be removed, exchanged with passive safety types or protected with safety barriers and/or crash cushions (see section 2.2).
Safety zone width (S)	The safety zone width is measured from the edge of the carriageway and perpendicularly out into the roadside terrain. The safety zone width depends on the safety distance (A) and any additions (see 2.2.2).
Shoulder	The part of the road that lies outside the edge line.
Shoulder width	The shoulder width is measured from the middle of the edge line to the edge of the shoulder. On gravel roads, the shoulder width is measured as the distance between the defined carriageway edge and the edge of the shoulder.
Single sided safety barriers	Safety barriers installed to protect against impact from only one side (e.g. steel safety barriers with steel beams on only one side of the post (Figure 1.1)).
Spacer	Element placed between the safety fence beam/back rail and the post, and which deforms on impact to give the safety fence more flexibility and to absorb energy.
Snow removal fences	Safety barriers that reduce the risk of large and/or heavy blocks of snow and/or ice from being moved/falling onto other parts of the road network during snow clearance operations. This may be achieved by using limited sized openings (cladding or mesh).
Speed level	Representative value for speed along a stretch of road or at a section of the road. The representative level can be the 85% speed (the speed that 85% of the drivers do not exceed) (see section 1.9.1.9).
Standard steel safety fences	Safety barriers that consist of posts, a steel beam with an A profile and with a 310 mm profile height, and fasteners (see Figure 1.1).
Terminal	The start or end section of safety barriers/embankments. See safety fence terminal.
Top of embankment	The cutting line between the road shoulder and the embankment or ditch slope.
Top rail	Rail placed on top of concrete safety barriers (see Figure 1.3).

Traffic delineators	Physical dividers between streams of traffic, e.g. between a road for motor vehicles and a footway and cycle track.
Traffic lane	Each individual lane into which a carriageway is divided, or which is wide enough for a single line of vehicles.
Transitions	Transitions between different types of safety barriers, or between safety barriers that have different degrees of stiffness.
Vehicle Intrusion (VI)	The maximum dynamic lateral position of Heavy Goods Vehicle (HGV) from the undeformed traffic side of the barrier during an impact (see Figure 1.5).
Vertical angle point	The intersection between the line extending from the carriageway and the top of the cut slope, or from the ditch bottom and the foot of the cut slope.
Working width	Cf. NS-EN 1317-2. the maximum lateral distance between any part of the barrier on the undeformed traffic side and the maximum dynamic position of any part of the barrier. Normalised Working Width (W_n) is calculated from the measured working width (W_m) and other test data (speed, vehicle weight, angle). In this manual, working width refers to the Normalised Working Width (W_n) unless otherwise specified.
Årsdøgntrafikk (ÅDT)	Det totale antall kjøretøy som passerer et snitt på en veg i løpet av et år, dividert med 365. Det benyttes dagens ÅDT for eksisterende veg og prognose ÅDT for ny veg.

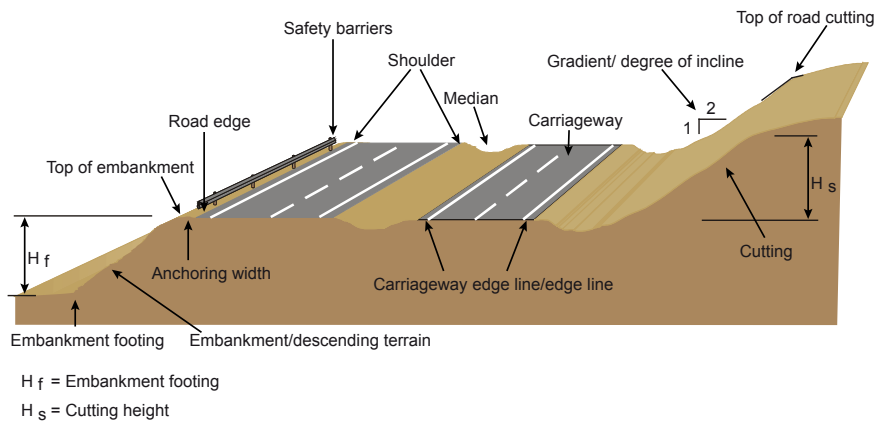

Figure 1.2 Road profile

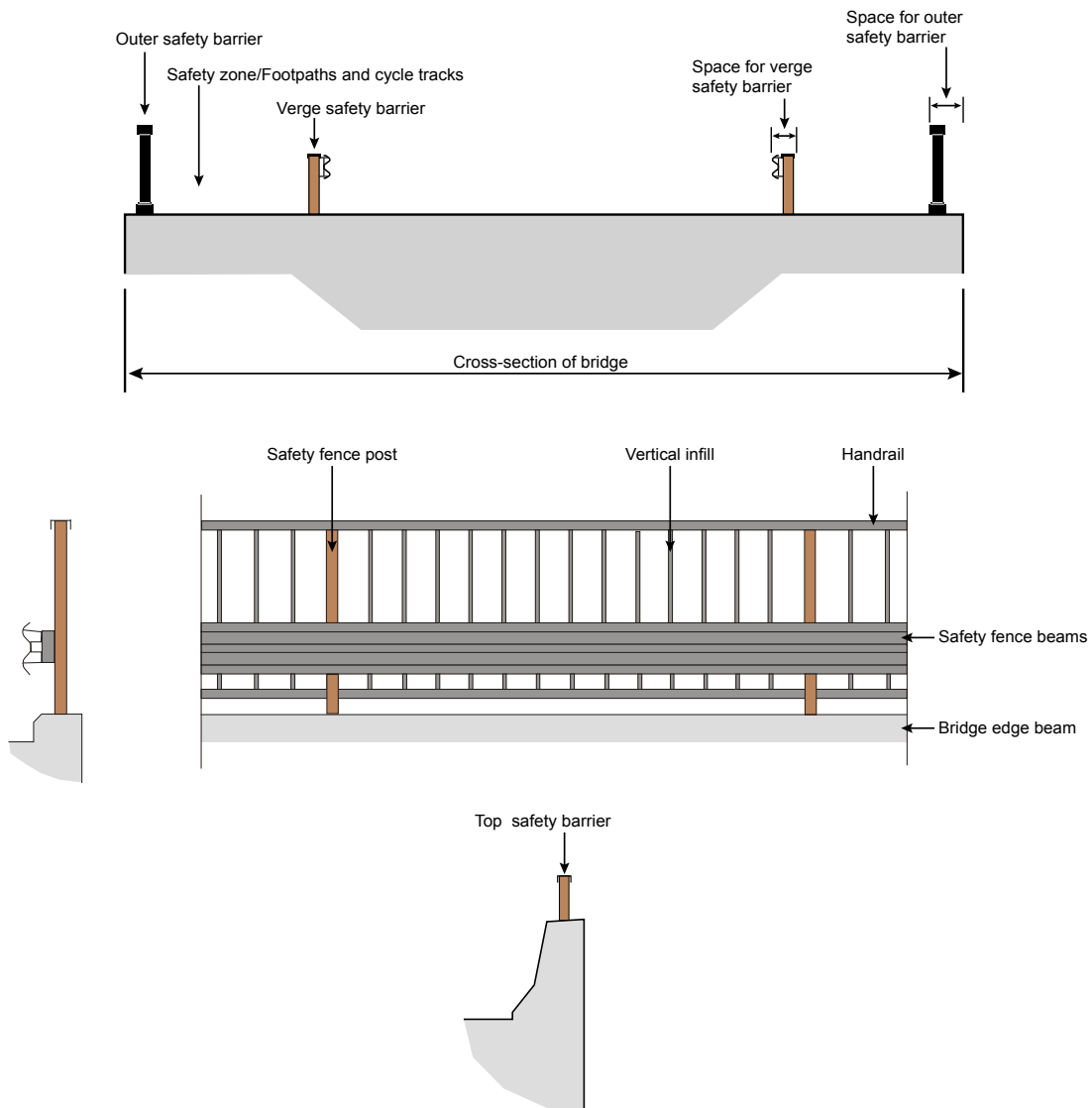

Figure 1.3 Different types of bridge parapets and their components

1.8 Designations

Designation	Explanation
ASI	<i>Acceleration severity index.</i> The value that describes the degree of severity of an accident. The value is the result of the vehicle's deceleration in the x, y and z directions.
THIV	Theoretical head impact velocity. The value that describes the degree of severity of an accident. The value is the result of the theoretical speed of a person's head against the interior of the vehicle during an impact.
A	the safety distance
B	width of the guardrail before collision, from the front edge to the back edge of the safety barrier, including any safety fence posts.
D	maximum dynamic deformation of the safety barrier on impact (dynamic deformation). D = the distance between the safety barrier's front edge before impact collision and the front edge after the impact.
T	horizontal width of steep side slopes (> 1:4) that are included in the calculation of the safety zone's width (S) in the case of steep embankments.
F	distance from the safety barrier's front edge to the back edge of the obstacle in the roadside safety zone.
H _f	height of the embankment (see Figure 1.2)

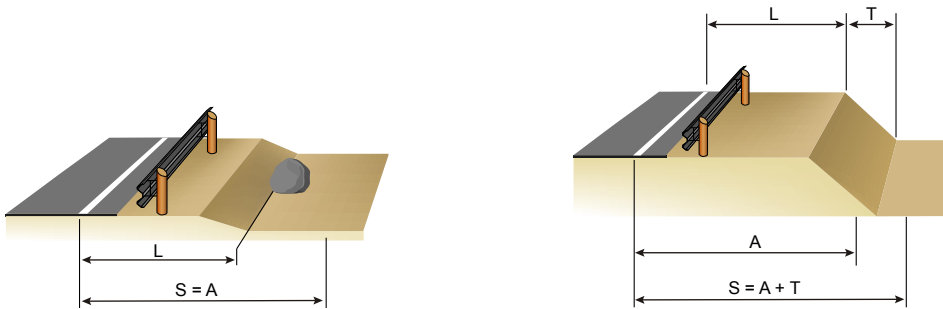

Figure 1.4 The parameters L, T, A and S

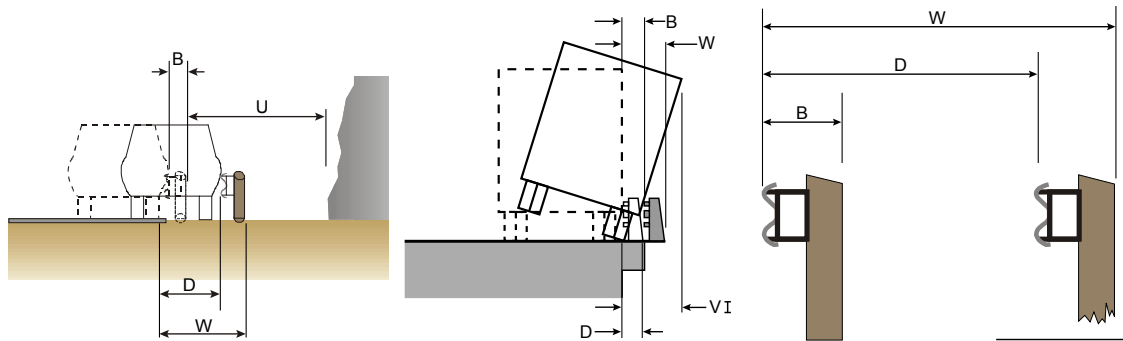

Figure 1.5 Working width (W), dynamic deformation (D), and guardrail width before collision (B)

H_s	height of the road cut (see Figure 1.2)
K	distance from the carriageway edge to the front face of the safety barrier
L	distance from the carriageway edge to the hazard. L is used to establish whether there is a need for safety barriers at the location ($L \leq S$) (see Figure 1.4)
R	horizontal curve radius
R_{min}	minimum horizontal radius that can be used given the road type's geometric design, cf. Manual 017 Street and road design (<i>Veg- og gateutforming</i>)
S	width of the safety zone, measured from the carriageway edge
U	displacement space behind the safety barriers. Available distance for the safety barrier's dynamic deformation between the barrier's back edge before impact and a hazard behind the barrier, e.g. the top of a slope or a roadside obstacle (see Figure 1.5)
VI	the penetration of a heavy goods vehicle in an impact with the safety barriers on the side of the road. VI is the maximum distance between the safety barrier's front edge before impact and the vehicle's outer edge on the penetration side, including any roll of the vehicle (see Figure 1.5).
W	the safety barrier's maximum working width. W is the distance (the highest measured value) between the front of the safety barrier before impact and the safety barrier's back edge during the impact.

1.9 Speed limits/speed levels as a basis for design

This standard contains a number of tables with design criteria linked to the road's speed limit. Where the actual speed level deviates significantly from the speed limit (at least 10 km/h deviation over a long stretch) the road's speed level shall be used as the basis for design. Local speed differences that, for example, are limited to an individual curve or some S curves, are not considered significant deviations. In this context, speed level refers to the 85% speed (i.e. the speed under which 85% of the vehicles drive, or the speed which 15% of the vehicles exceed).

2 Calculations for safety zones and the need for safety barriers

2.1 General

Safety barriers and/or crash cushions shall be installed where there is one or more hazards within the safety zone (see section 2.2), and where it is more dangerous to impact the hazards than to impact a safety barrier or crash cushion (see section 2.3 through 2.11.5).

These hazards may be divided into four main categories:

- **Fixed roadside obstacles** that will pose a serious risk of injury or damage on impact. This may be roadside obstacles that are part of the road's construction (protruding culverts, abutments and piers etc.), roadside furniture (lighting columns, sign posts etc.), elements in the terrain outside the body of the road (stones, rock, water, large trees etc.) or other structures (walls, buildings etc.),
- **Dangerous side slopes** that have a form that will overturn or abruptly stop a vehicle if it drives off the road.
- **Other road users**, for example pedestrians and cyclists or motorists travelling in the opposite direction who will be exposed to serious risk of injury or damage if a vehicle drives off the road.
- **Special installations** in the roadside area, such as parallel and crossing railway or metro tracks, fuel tanks, water reservoirs etc. that, in the case of a vehicle driving off the road, may result in secondary accidents with very serious and extensive consequential injury and damage.

Safety barriers shall be used at precipices, embankments, bridges, retaining walls etc. if their height exceeds the minimum values in Tables 2.6 and 2.7. The need for safety barriers by dangerous roadside obstacles, lakes, bridges and retaining walls is discussed in more detail in sections 2.6 – 2.9.

Safety barriers shall also be erected in certain situations to protect other road users against errant vehicles that have ended up in the wrong place, for example in the median (see section 2.7 and 2.11), and protect against parallel roads, footpaths and cycle tracks, railways and metro tracks near the road, and special roadside installations (see 2.2.8). Special types of safety barriers are used in connection with the working area within the safety zone, see 2.11.5.

Furthermore, safety barriers shall be erected on the basis of a risk analysis along the outside of pavements, footpaths and cycle tracks, on high embankments and retaining walls, and on bridges for pedestrians and cyclists to ensure that vulnerable road users do not fall over the edge (see section 3.7).

Before a decision is made to erect safety barriers or crash cushions, alternative solutions should be evaluated. This may be to

- remove or move the hazard
- ease the gradient of embankments and road banks
- use sealed ditches

- widen the terrain strip against the road cut and or build a bank against the road cut
- use passive safe devices (applies to lighting columns, sign posts etc.)
- use a crash cushion if this is more appropriate

Safety barriers shall not be erected to improve aesthetics where safety barriers, according to the criteria, are not required. In such cases, other devices, such as edge posts, direction markings, lighting etc. must be considered. Safety barriers must not be placed in such a way that they provide misleading visual guidelines.

During road planning, visibility shall be assessed in accordance with Manual 265 because safety barriers can obstruct the view. The problem is especially important for junctions at the end of a bridge and at inner curves over summits. This ought to be avoided as much as possible by means of one or more of the following measures:

- move the junction or change the line profile
- select solutions that do not require safety barriers
- select a safety barrier that is least obstructive to the view
- select the alignment of the safety barrier that is least obstructive to the view

2.1.1 Requirements for documentation of road equipment

As of 1 January 2011, CE marking applies to safety barriers and crash cushions within the EEA, while CE marking for lighting columns applies as of 1 January 2010. Safety barriers, crash cushions and lighting columns shall be approved by a Notified body.

The CE mark is not a requirement to sell such road equipment in Norway. However, all tests required for such marking must have been carried out with positive results. Norway has safety requirements and other requirements that exceed the CE mark requirements; e.g. motorists must not be killed when the test situation occurs in reality.

Even if guardrails or other road equipment is CE marked, the Directorate of Public Roads will want to see the test report as well as drawings and installation instructions, and will include these products in a list of vehicle restraint systems for use on county and national roads in Norway.

The Directorate of Public Roads has the right to refuse to use CE marked products in Norway based on traffic safety, service life considerations, maintenance concerns and other special concerns, and the right to permit a non-approved product based on the same arguments. This will be noted in the list of road safe equipment for use on county and national roads in Norway(www.vegvesen.no).

All vehicle restraint systems defined as structures shall be included on the same lists as described above when the requirements are met.

2.2 Safety zone width, S

For road safety reasons, a safety zone is defined which extends away from the carriageway edge. It is designed so that vehicles that leave the carriageway

- cannot hit dangerous roadside obstacles
- can avoid rolling over
- can come to a gradual stop, or
- can return to the carriageway in a controlled manner, without being a hazard to other vehicles
- cannot hit other road users or drive into an area designated for people
- cannot impact high risk hazards, a collision with which could result in major consequential damage or injuries.

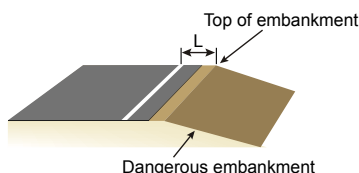
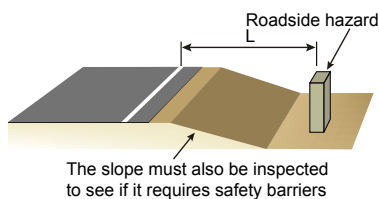

Figure 2.1 Avstånd til faremomentet (L)

The distance L from the edge of the carriageway to the hazard is measured perpendicularly and horizontally out from the carriageway edge to the kerbside edge of the roadside obstacle, see Figure 2.1.

If any of the requirements for safe roadside terrain are not met within the safety zone’s width (S), safety barriers shall be installed. Special rules apply for urban areas, see 2.2.1. See also section 1.2.

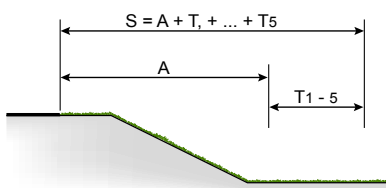

Figure 2.2 Criteria for safety zone width’s calculation

The safety zone width is established based on the amount of traffic, speed limit, curvature, distance to oncoming traffic lanes if there is a median, and the design or content of the roadside terrain. It is also important to make an evaluation of the area just outside the safety zone. Where especially hazardous elements are found just outside the safety zone, an evaluation of whether to remove the element or install safety barriers should be made. To determine the safety zone’s width, a safety distance (A) must first be established, see 2.2.1. This is used as a starting point for the calculation of the width of the road’s safety zone (S) starting with the following formula:

$$S = A + T_1 + T_2 + T_3 + T_4 + T_5$$

S = Safety zone width

A = Safety distance, see Table 2.2

T1 = Any addition for sharp curves, see Table 2.1

T2 = Any addition/deduction for gradients, see Table 2.1

T3 = Any addition for other road users, railways, see Table 2.1

T4 = Any addition for high risk hazards, see Table 2.1

T5 = Any addition for medians, see Table 2.1

Calculating the width of the safety zone			
$S = A + T_1 + T_2 + T_3 + T_4 + T_5$			
A, safety distance	Determined on the basis of AADT and speed at the location		See Table 2.2
T₁ addition for sharp curves	Curves with horizontal radius: $R < R_{min}^*$		$T_1 = 2 \text{ m}$ See 2.2
T₂ addition/deduction for gradients	Embankment (Falling gradient)	1:4 or flatter	$T_2 = 0 \text{ m}$ See 2.2.2
		Steeper than 1:4	$T_2 = \text{side slope width}$
	Slope (Rising gradient)	Flatter than 1:2	$T_2 = 0 \text{ m}$ See 2.2.3
		1:2	$T_2 = 0 \text{ m}$, or S is limited by the distance to a road cut height of 2.0 m above the carriageway level if this lies within A.
	Steeper than 1:2	$T_2 = 0 \text{ m}$, or S is limited by the distance to a road cut height of 1.6 m above the carriageway level if this lies within A	
T₃ addition for	Road or footway/cycle way under road		$T_3 = 0,5 \times A$ See 2.2.5
	Railway		$T_3 = A$ See 2.11.3
T₄ addition for high risk hazards	Playground, schools, fuel tanks, water reservoirs etc.		$T_4 = 0,5 \times A$ See 2.11.4 and 2.2.8
medians			$T_5 = A$ See 2.7 and 2.2.9

* R_{min} for the various road classes is found in Manual 017.

Table 2.1 Calculating the width of the safety zone

2.2.1 Safety distance, A

Table 2.2 below gives the road's safety distance (A) based on the speed limit and amount of traffic.

Usually, the road speed limit is used as a design basis for establishing the safety distance. Where the actual road speed level varies significantly from the speed limit, the road speed level is used as the design basis (see section 1.9).

The AADT for new roads is the anticipated AADT 20 years after the road is opened. For existing roads, it is the current amount of traffic.

AADT	Speed limit (km/h)			
	50*	60**	70 and 80	≥90
0-1500	2,5 m	3 m	5 m	6 m
1500-4000	3 m	4 m	6 m	7 m
4000-12000	4	5 m	7 m	8 m
>12000	5 m***	6 m***	8 m***	10 m***

* For streets and roads with a speed limit of 50 km/h or lower, in cities and densely populated areas, Table 2.2 applies only in the following situations:

- Where safety barriers are required on embankments/downward sloping terrain and precipices in accordance with Table 2.6 and Table 2.7.
- Tunnel openings and tunnel arches that extend out from the tunnel wall and which have a dangerous shape.
- Road, foot path and cycle way underpass.
- Railway or metro lines that crosses under or are located parallel to the road
- Playgrounds, day-care centres and school yards
- Other high risk hazards such as fuelling facilities and water reservoirs.

** Trees along avenues that are within the safety distance in 60 km/h zones can, after closer evaluation, remain in the outer half of the safety distance.

*** Applies to new roads only. For existing roads use values for AADT of 4,000-12,000

Tabell 2.2 Requirements for the safety distance (A) along a road, based on AADT and speed.

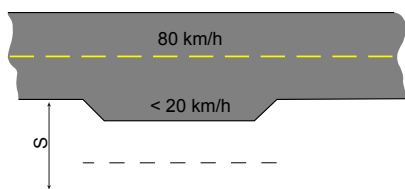

Figure 2.3 Safety distance at bus bays, breakdown bays, etc.

The safety distance with respect to ramps and acceleration/deceleration lanes is determined based on current speed limits for the lane/ramp, and the ramp’s acceleration or deceleration lane’s AADT.

In areas intended for vehicles to stop, such as bus bays, lay-bys, parking places, viewing points and similar, the safety distance is according to the lowest speed and AADT class. This applies only if the outer limit of the safety distance is not less than for the adjacent road.

2.2.2 Addition for sharp curves, T1

For sharp curves, driving off the outer curve of the road happens at a greater angle than along a straight stretch, and the distance by which the vehicle leaves the road will therefore often be greater. The safety zone width (S) is increased by 2 metres if the curve’s horizontal radius is less than R_{min} . R_{min} is the minimum radius allowed on a road. These values are found in Manual 017 Road and street design (*Veg- og gateutforming*) for the various design classes. Curves that are sharper than R_{min} can sometimes be found on existing roads.

Curve radius	Safety zone width (S)
$R < R_{min}$	$S = A + T_1$ ($T_1 = 2\text{ m}$)

Table 2.3 Addition T1 to the safety distance (A) on sharp curves

2.2.3 Addition for embankments/falling gradient, T_2

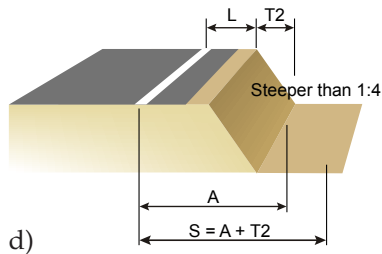
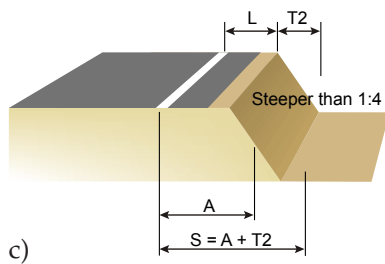
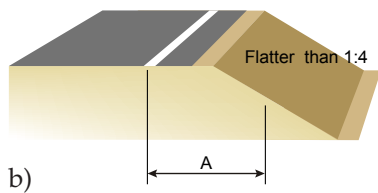
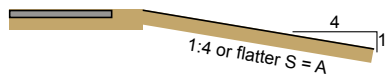

Figure 2.4 Safety zone width for embankments (falling gradient)

The gradient of the road’s embankment is critical for the calculation of the safety zone width (S). The gradient will affect how a vehicle that drives off the road will behave when it ends up on the side slope.

Gentle embankments (gradient of 1:4 or flatter)

$$S = A$$

$$S = A + T_2, (T_2=0)$$

The safety zone width (S) is equal to the safety distance (A) from Table 2.2. In this case, the addition T_2 is equal to 0 metres. The slope is so gentle that, to a certain extent, the driver will be able to slow down, gain control and possibly drive back onto the carriageway. The embankment is therefore included in the safety zone width (S). See Figure 2.4 b.

Steep embankments (gradient of 1:4 or steeper)

$$S > A$$

$$S = A + T_2 (T_2 > 0)$$

The safety zone’s width (S) is equal to the safety distance (A) plus addition T_2 , when $A >$ the distance to the top of the road bank (L) (see Figure 2.4 c), and when $A >$ the distance to the top of the bank (L) + T_2 (see Figure 2.4 d). In this case, the addition T_2 is equal to the width of the slope when the slope is steeper than 1:4.

Embankments with a falling gradient of 1:4 or steeper will result in mandatory guiding of the vehicle down to the foot of the bank.

Falling gradient	Safety zone’s width (S)
1:4 or flatter	$S =$ The safety distance (A)
Steeper than 1:4	$S = A + T_2$, $T_2 =$ the embankment’s width

Table 2.4 Addition T_2 to the safety distance (A) for embankments with a falling gradient

The distance to the top and bottom of the embankment is measured to the vertical angle point. Examples of calculating the safety zone’s width (S) are given in Appendix 2.

On steep embankments (gradients of 1:4 or steeper) the transition between the top and bottom of the bank must be rounded to reduce the danger of vehicles rolling over on the side slope.

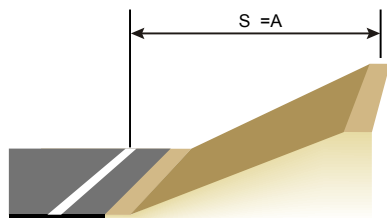

a) Rising gradient less than 1:2

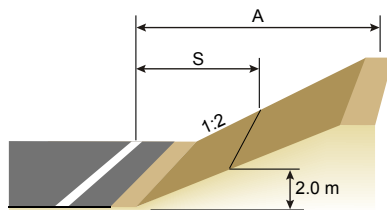

b) Gradient 1:2

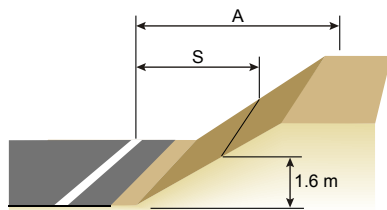

c) Gradient more than 1:2

Figure 2.5 a)-c) Safety zone width's limit for slopes (rising terrain).

2.2.4 Addition for slopes/ rising gradient, T_2

The cut slope gradient and the shape of the transition between the ditch and the slope up from the road are decisive for how a vehicle will behave when it drives off the road.

Gently inclined slopes (rising gradient flatter than 1:2)

$$S = A$$

$$S = A + T_2 \quad (T_2 = 0)$$

For gentle cut slopes with a soft transition from the roadway to the slope and no other roadside hazards, the safety zone width (S) will be equal to the safety zone distance (A) from Table 2.2. The addition T_2 is equal to 0 meter (see Figure 2.5 a). The gradient is so gentle that to a certain extent the driver will be able to slow down, gain control and possibly drive back onto the carriageway.

Normal cut slopes (rising gradient 1:2)

$$S \leq A,$$

$$S = A + T_2 \quad (T_2 < 0)$$

$(T_2 = \text{minus the part of } A \text{ which is more than 2.0 m above the carriageway})$

For normal cut slopes (1:2 gradient) the safety zone width (S) is extended only up to the point where the slope height is 2.0 metres above the carriageway level, in as far as this lies within the safety distance (A) (see Figure 2.5 b). T_2 is then subtracted from the part of the safety distance (A) that lies more than 2.0 metres above the carriageway.

Steep cut slopes (rising gradients of more than 1:2)

$$S \leq A$$

$$S = A + T_2 \quad (T_2 < 0)$$

$(T_2 = \text{the part of } A \text{ that lies above 1.6 m over the carriageway})$

For steep cut slopes (gradients of more than 1:2) the safety zone width (S) is extended only up to the point where the slope height is 1.6 m above the carriageway, in as far as it lies within the safety distance (A) (see Figure 2.5 c). T_2 is then subtracted from the part of the safety distance (A) that lies more than 1.6 metres above the carriageway.

The slope gradient	Safety zone width (S)
Less than 1:2	S = The safety distance (A)
1:2	$S \leq A$, (S is restricted to the distance to a cut slope height of 2.0 m above the carriageway level if this lies within A)
More than 1:2	$S \leq A$, (S is restricted to the distance to a cut slope height of 1.6 m above the carriageway level if this lies within A)

Table 2.5 Addition T2 to safety distance (A) for rising gradients

2.2.5 Addition for roadway, footway or cycle track underpass, T_3

For roadways or footways and cycle track underpasses, an addition of $0.5 \times A$ is added to the safety distance (A) from Table 2.2 to establish the width of the road’s safety zone (S) and calculate the need for safety barriers.

$$S = A + T_3 \quad \text{hvor} \quad T_3 = 0,5 \times A$$

This is necessary due to the high level of damage/injury that could occur if a vehicle were to drive off the road and travel on the roadway/footway or cycle track. In the case of agricultural underpasses or roads with very little traffic, each individual case is separately evaluated as to whether it is necessary to increase the safety distance by $0.5 \times A$.

2.2.6 Addition for railways, metro lines etc., T_3

For railways, metro lines etc., that are parallel to the road or that cross under the road, addition $T_3 = A$ is added to the safety distance (A) from Table 2.2 to establish the width of the road’s safety zone (S) and calculate the need for safety barriers.

$$S = A + T_3 \quad \text{where} \quad T_3 = A$$

However, it may be necessary to increase the safety zone’s width (S) further in certain situations due to the high level of damage/injury that could occur if a vehicle should end up on the tracks.

2.2.7 Addition for areas where people congregate, T_4

For playgrounds, day-care facilities, schoolyards and camping sites that lie next to the road, an addition (T_4) of $0.5 \times A$ is added to the safety distance (A) from Table 2.2 to establish the width of the road’s safety zone (S) and calculate the need for safety barriers. This is done due to the high level of injury that could occur.

$$S = A + T_4 \quad \text{where} \quad T_4 = 0,5 \times A$$

In cases where consequential injury from driving off the road can be especially great, even wider safety zones may be imposed.

2.2.8 Addition for special installations, T_4

Due to the risk of great consequential damage/injury in the case of collision with risk hazards in the roadside area, an addition $T_4=0.5 \times A$ is added to the safety distance (A) from Table 2.2 to establish the width of the road's safety zone (S) and the need for safety barriers. This is due to the high level of consequential damage/injury that can result if a vehicle should end up outside of the road at such installations. These may include:

- Installations where major secondary accidents could occur in a collision, for example, fuel tanks
- Installations where driving off the carriageway could entail major environmental damage, for example water reservoirs that ought to be protected against any fuel tanker vehicles that might drive off the carriageway, etc.

$$S=A+T_4 \quad \text{hvor} \quad T_4 = 0,5 \times A$$

In cases where the consequential damage from driving off the carriageway can be especially great, using even larger safety zones may be appropriate.

Other special places where there may be a need to increase the safety zone's width must be specially evaluated.

2.2.9 Addition for medians, T_5

In the case of medians, an addition (T_5) is added to the safety distance (A) in the central reservation from Table 2.2 to establish the width of the road's safety zone (S) and calculate the need for safety barriers. This is due to the major consequential damage/injury that could occur should a vehicle enter into a lane with oncoming traffic.

$$S = A + T_5 \quad \text{hvor} \quad T_5 = A$$

In cases where the consequential damages/injury from an incident can be especially great, it may be appropriate to impose even wider safety zones, so that the medians are wider than 2A.

2.2.10 Overhead clearance in the safety zone area

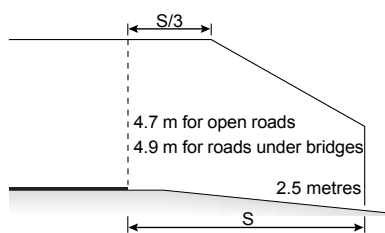

Figure 2.6 Overhead clearance above the safety zone (S) at locations without safety barriers

Requirements for overhead clearance above the carriageway in the safety zone are based on concerns for the safety of high vehicles such as buses and articulated lorries in the safety zone.

Hazards above the carriageway can be overhanging signs and sign gantries, bridges including slanting bridge pillars, tunnel portals, noise barriers with walls that slant over the shoulder or carriageway, etc. The minimum overhead clearance requirements above the carriageway, are defined in Manual 017 Road and street design (*Veg og gateutforming*), Manual 021 Road Tunnels (*Veg tunneler*) and Manual 185 Bridge design (*Prosjekteringsregler for bruer*). These shall be continued into the safety zone according to the following rules.

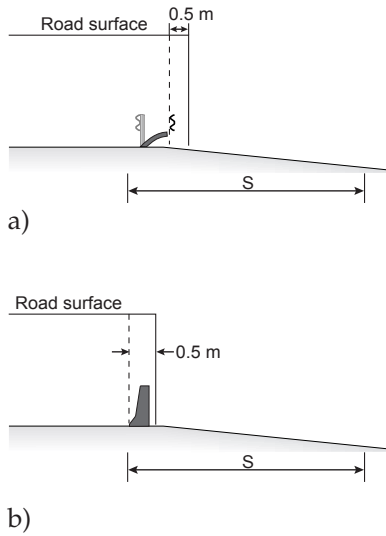

Figure 2.7 a) b) Overhead clearance in the safety zone at locations with safety barriers

- Where there are no safety barriers, the requirement for overhead clearance will decrease with the distance from the road edge, see Figure 2.6. Where there is an obstacle in the safety zone (e.g. a rock cut) that does not require safety barriers, the overhead clearance will be as in Figure 2.6, with correspondingly shorter distances.
- Where there are deformable safety barriers (with a dynamic deflection greater than 0.5 m), the requirement for overhead clearance remains constant up to the safety barrier’s dynamic deflection, but with a minimum of 1.0 m because deflection is in this case insignificant, see Figure 2.7 a).
- Where there are rigid safety barriers (dynamic deflection D is ≤ 0.5 m), full overhead clearance is required up to the safety barrier’s dynamic deflection, plus 0.5 m for any penetration caused by the vehicle tilting on collision, see Figure 2.7 b).

2.3 The need for safety barriers on embankments

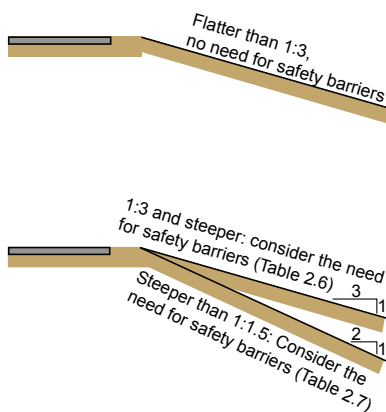

Figure 2.8 Need for safety barriers, determined by the falling gradient of the side slope

A vehicle will normally not roll over on a gradient between 1:3 and 1:4, but the driver will not be able to recover control of the vehicle. The vehicle will therefore end up at the foot of the bank if driving off the carriageway onto such slopes. The safety zone must therefore be checked for hazardous roadside obstacles on the road bank or at the foot of the bank (see section 2.6). If hazards cannot be avoided, safety barriers must be installed.

On falling roadside gradients of 1:3 or steeper, the danger of a vehicle rolling over increases significantly. Where such gradients cannot be avoided, the need for safety barriers shall be considered according to Table 2.6. Embankments with gradients steeper than 1:1.5, are considered to be precipices, resulting in a high risk of vehicle rollover and significant consequential injury if a vehicle should veer off the carriageway. In such locations, the need for safety barriers shall be considered according to Table 2.7.

If the top of the road bank is within the safety zone and the sum of the heights of banks with a gradient of 1:3 or steeper is greater than the longest permitted bank height (H) in Table 2.6 and Table 2.7, safety barriers must be installed.

AADT	Bank height (falling gradient) H			
	Bank gradient*	Speed limit ≤ 60 km/h	Speed limit 70 og 80 km/h	Speed limit ≥ 90 km/h
0 – 4 000	1:1,5	3 m	2 m	1,5 m
	1:2	5 m	3 m	2 m
	1:3	8 m	6 m	4 m
4 000 – 12 000	1:1,5	3 m	2 m	1 m
	1:2	4 m	3 m	1,5 m
	1:3	7 m	4 m	3 m
> 12 000	1:1,5	2 m	1,5 m	1 m
	1:2	3 m	2 m	1,5 m
	1:3	5 m	3 m	2 m

*Intermediate values must be interpolated. Embankments with falling gradients steeper than 1:1.5 are considered to be equal to a precipice (see Table 2.7).

Table 2.6 Highest permitted bank height (H) without safety barriers at falling gradients of 1:2 and 1:3, with different amounts of traffic and speed limits.

Height (metres)	0 - 1 metres from the carriageway	1-3 metres from the carriageway
0 – 0,3	No need for safety barriers	No need for safety barriers
0,31 – 1,0	Need for safety barriers	No need for safety barriers
1,01 – 4,0	Permitted for pedestrians/-cyclists Need for safety barriers, see chapter. 3.7	Need for safety barriers See section 3.2
≥ 4,0	Need for safety barriers, height ≥ 1.2 m, H2 class	Need for safety barriers, H2 class See section 3.2

The area 0 – 1.0 m from the carriageway should be relatively level

Table 2.7 Highest permitted bank height (H) without safety barriers at falling gradients of 1:1.5 or steeper

Examples of calculations relating to the need for safety barriers on embankments are given in Appendix 2.

2.4 The need for safety barriers at road cuttings, deep ditches etc.

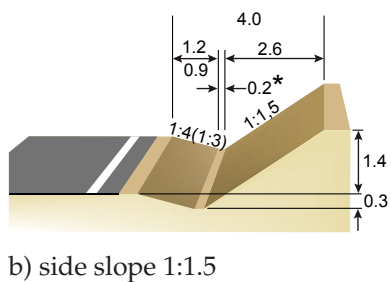
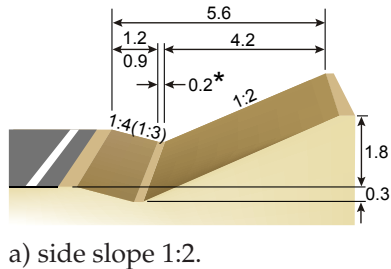

Figure 2.9 Requirements for closed ditches.
* can vary from 0.2 – 0.5

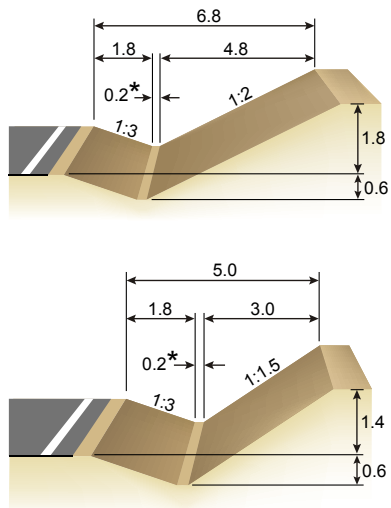

Figure 2.10 Requirements for open ditches
(speed limit $\leq 80\text{km/h}$).
* can vary from 0.2 – 0.5

Road cuttings as illustrated in Figs 2.9 and 2.10 are not considered to be dangerous and need not be protected with safety barriers except if dangerous roadside obstacles are located in the ditch or on the ditch slope and cannot be secured in any other way, and when the obstacle is located less than 1.6 m/2.0 above the carriageway, see section 2.2.4 (to prevent driving off the carriageway and onto the embankment, see section 3.3.3).

If there are protruding large stones and rocks of 0.3 m or more within the safety zone, these must be blasted away or covered. If this is not financially feasible, the protruding parts must be treated as dangerous roadside obstacles with respect to calculating the distance to the hazard (L) and the need for safety barriers within the safety zone.

Open ditches ought to be designed as illustrated in Figure 2.10. Closed ditches are safer than open ditches and are therefore preferable. The minimum requirements for the design of closed ditches are shown on Figure 2.9. Deep ditches with steep sides are dangerous to traffic and ought to be avoided, especially against rock cuttings. (Ditches in rock, where rock cuts form the back of the ditch, are considered under certain conditions, as dangerous roadside obstacles with respect to the need for safety barriers, see sections 2.5 and 2.6)

2.5 The need for safety barriers at rock cuttings

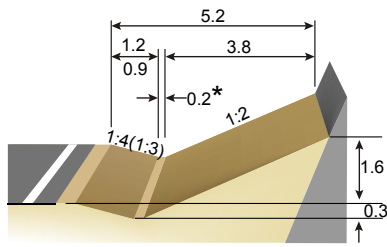

a) Side slope gradient of 1:2 .

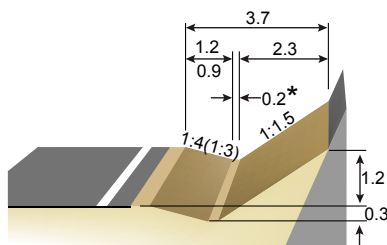

b) Side slope gradient of 1:1.5

Figure 2.11 Requirements for earth bank against rock cuttings.

* can vary from 0.2 – 0.5

To avoid the used of safety barriers, rock cuttings should be blasted out with as smooth a surface as possible due to the risk that they might pose vehicles leaving the carriageway. Protruding parts with sharp edges in any part of the cutting with which a vehicle may come into contact, and which would entail a sudden stop with the risk of great personal injury as a result, ought therefore to be avoided. The areas concerned ought not to have parts that protrude more than 0.3 m. If this is not financially feasible, the rock cut must be treated as a dangerous roadside obstacle with respect to the distance to the hazard (L) and the need for safety barriers within the safety zone (see sections 2.2 and 2.6).

A good alternative to setting up safety barriers against rock cuttings is to build up an earth bank against the rock cutting. To prevent impact with the rock cutting, the earth bank must be shaped as shown in Figure 2.11.

Where the gradient of an earth bank is 1:2 (see Figure 2.11 a), the slope height (h) above the carriageway level must be at least 1.6 m. With more gentle gradients than 1:2 and 1:1.5, safety barriers must be erected if the rock is within the safety zone.

Where the gradient of an earth bank is 1:1.5 (see Figure 2.11 b), the slope height (h) above the carriageway level must be at least 1.2 m. To be able to achieve a stable bank at a gradient of 1:1.5, special fill must be used, see Manual 018 Road Construction (Vegbygging).

To avoid safety barriers against ditches, the ditch depth shall be 0.3 m. On roads with speed limits ≤ 80 km/h, an alternative ditch depth of 0.6 m can be used.

Where there is space available, the use of earth mounds is preferable to safety barriers against rock cut slopes.

To ensure that rocks (or possibly ice) that loosen do not come to rest in the ditch or on the carriageway, collision-safe metal safety fences with additional low-level beams can be erected. Such safety fences are to be installed approx. 1 m from the rock face with the beam on the traffic side, and with posts 1-2 m apart.

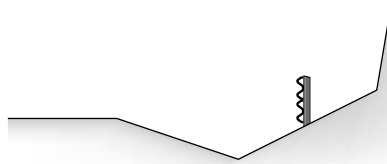

Figure 2.12 Use of guardrails at rock cuttings.

The termination of these safety fences must not represent a risk of injury. See sections 3.3.2 and 4.3. These safety fences will catch rocks and stones, depending on the amount of rocks and stones that loosen. Alternatively, an earth mound may be built against the rock face or arrestor mesh may be installed.

2.6 The need for safety barriers or crash cushions by hazardous roadside obstacles

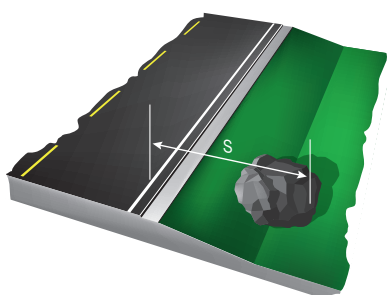

Figure 2.13 Example of a hazardous roadside obstacle which should not be found within the safety zone

It is required that safety barriers or crash cushions are installed in front of hazardous roadside obstacles that are inside the safety zone. The calculation of S is described in section 2.2.

Hazardous roadside obstacles are fixed objects that are so heavy and solid that they could cause serious personal injury in the case of a collision. Examples include:

- Bridge pillars and abutments
- Non-passive safe posts, lighting columns and sign posts
- Trees and wooden poles with a diameter > 15 cm measured 40 cm above the ground
- Large, non-passive safe traffic portals or similar
- Retaining walls, masonry structures or similar (with edges that protrude more than 30 cm). Noise barriers with protruding parts or dangerous posts within or in connection with a structure that may be subject to fragmentation.
- Concrete buffers at toll stations
- Concrete foundations, manholes, rocks buried in the earth, tree stumps and similar objects that protrude more than 15 cm above the ground
- Culvert outlets, drain pipes etc. in embankments
- Large, sturdy cabinets, e.g. telephone cabinets, electricity cabinets, control cabinets and similar installations.
- Tunnel openings and tunnel arches that extend out from the tunnel wall
- The end of earth banks steeper than 1:10 and steep ditch terminations (1:6) at junctions and exit roads across the direction of the traffic. See sections 3.3.3 and 4.3.4

These types of hazardous roadside obstacles must not occur within the road's safety zone. If it is appropriate, they can be rebuilt or replaced with passive safe structures that have been tested to NS EN 12767, or device crash cushion or a redirective safety barrier may be installed in front of the objects (see Chapter 6).

Passive safe supports may be placed behind the safety barriers, within the outer $\frac{3}{4}$ of their working width W , in so far as the devices does not affect the safety barrier's performance in a collision. If the barrier has a 'smooth' traffic face (protruding sections smaller than 10 cm) against the passive safe support, it is considered not to affect the barrier's performance on impact.

If a noise barrier that has not been tested and approved for impact to NS-EN 1317 is placed within the safety zone, it must be protected against impact with a safety barrier in front of the noise barrier. In certain cases, a noise barrier may be combined with a safety barrier, for example when a cast-on-site concrete barrier forms part (the foot) of the noise barrier. The noise barrier must not affect the barrier's performance. The noise barrier must not detach from the safety barrier, lose fragments or in any other way represent a risk to road users. The end section of a noise barrier can be especially dangerous and it shall therefore either be placed outside the safety zone or be protected with safety barriers or a crash cushion.

2.7 The need of safety barriers at medians

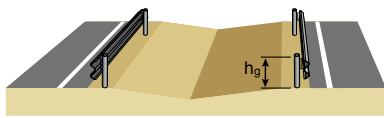

Median strip gradient steeper than 1:5

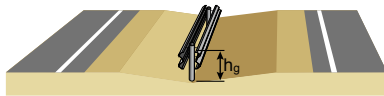

Median strip gradient gentler than 1:5

Figure 2.14 Single- and double-sided safety barriers in the medians relative to the median's gradient.

Safety barriers or earth embankments are required in the physical median for multi-lane roads if the distance between the edges of the carriageways with traffic in opposite directions is less than twice the safety distance width, and the ditch has a slope of 1:5 or less, see Figure 2.14. Roads with speed limits ≤ 60 km/h are subject to special consideration. For earth embankments as safety barrier replacements, see section 3.3.5.

Passive safe dangerous and columns must not be used as an alternative to safety barriers or crash cushions in front of hazardous roadside obstacles, or instead of safety barriers in the median.

If the median incorporates trees with a larger diameter when fully grown than that specified in section 2.6, or any other dangerous roadside obstacles such as passive safe signposts, lighting columns or other structures, the need for safety barriers is to be assessed in accordance with sections 2.2 and 2.6.

If two single-sided safety barriers are erected in the median, passive safe support of an approved type (NS EN12767) can be installed between the barriers in accordance with section 2.6.

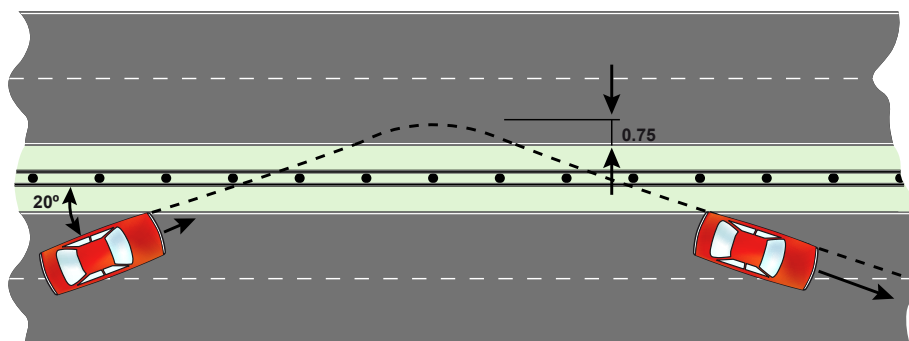

Figure 2.15 Maximum penetration into the lane of oncoming traffic for narrow medians

On roads with median safety barriers, the requirement for their working width is such that they can cover up to 0.75 m of the lane of oncoming traffic, see Figure 2.15.

Double-sided safety barriers can be erected in the middle or on one of the sides of the median if the gradient is 1:5 or less. For steeper gradients, two single-sided safety barriers at the top of the slope/shoulder edge may be erected (see Figure 2.14). Where there is a difference in height between lanes for traffic in opposite directions, it may be appropriate to place a double-sided safety barrier along the side of the highest carriageway. In locations where significant amounts of snow may be expected to be ploughed onto the median, consideration should be given to installing safety barriers on both sides.

2.7.1 Emergency and maintenance openings in medians

Medians with safety barriers must provide emergency openings for traffic or single vehicles to drive in a controlled manner into the opposite carriageway. Openings in median safety barriers should be found every third of a kilometre. Ordinary junctions replace this emergency opening. Emergency and maintenance openings in medians must be designed so that they do not represent a hazard for road users. Emergency openings must be closed with a safety barrier, gate or other device when not in use.

The length of permanent emergency and maintenance openings depends on the safety barrier, gate or device that is placed there. It will vary from 27 to 32 m. The opening for vehicles to pass through, must be at least 15 m. As an alternative to permanent emergency openings, simple safety barriers that can be dismantled may be used. These can be placed as frequently as one per km. They must be so simple to open that personnel from the emergency services can dismantle them by hand in a maximum of 10 minutes.

Special solutions that allow medians to be opened must be designed so that they do not represent any weakness in relation to adjacent safety barrier sections (cf. Section 4.5). Safety barrier components that become terminations when medians are opened, must be protected.

2.7.2 Erected Earth embankments as medians

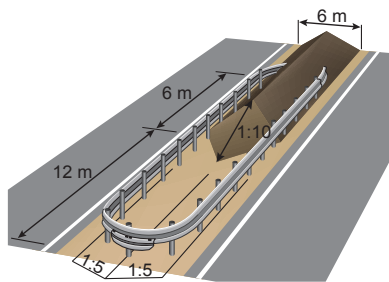

Figure 2.16 Example of protecting the end section of an earth embankment

Earth embankments can replace median safety barriers. To prevent driving over the embankment, a design as shown in Figure 2.17 is required.

On roads with speed limits/speed levels of ≥ 80 km/h, the embankment's end section must be protected with safety barriers, see Figure 2.16. On roads with speed limits < 80 km/h, a tapered earth embankment with a gradient of 1:10 may be used. The design of the embankment's end section against the traffic must be as specified in Figure 2.17.

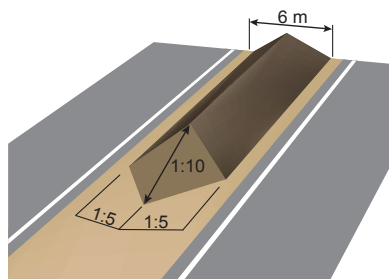

Figure 2.17 Minimum requirements for the design of earth embankment end sections

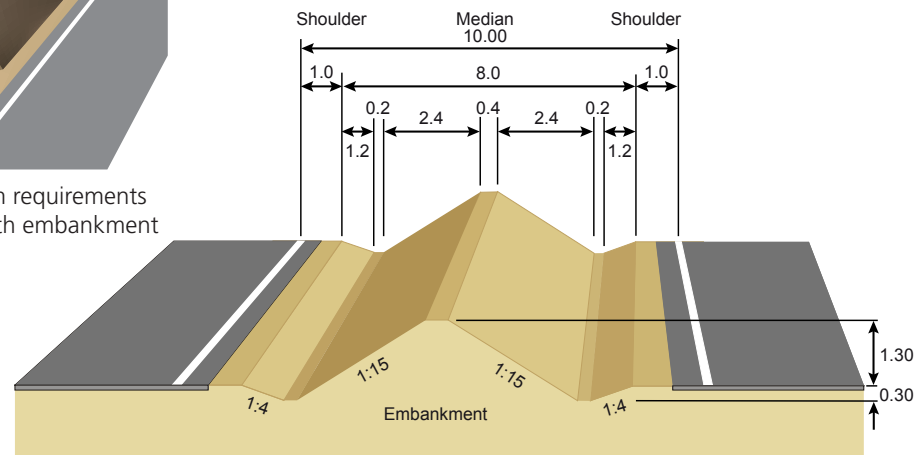

Figure 2.18 Minimum requirements for earth embankments that replace ordinary safety barriers (measured in metres)

2.8 The need for safety barriers by rivers, lakes and other water

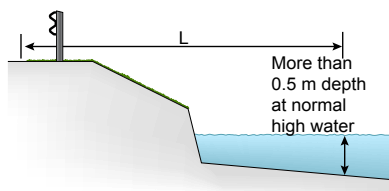

Figure 2.19 Requirements for safety barriers by deep water within the safety zone

Safety barriers are to be installed along rivers and other bodies of water within the safety zone where the water depth is more than 0.5 m at high tide. Normal spring floods in waterways are included. Extraordinary floods on the other hand, where the waterway greatly exceeds its usual course, occur infrequently and should not normally be taken into consideration.

The distance to the water depth that requires safety barriers is measured as the distance to the hazard (L) in Figure 2.99.

H2 containment level safety barriers are to be installed where there is a precipice down to the water.

2.9 The need for safety barriers on bridges, retaining walls and at precipices

In principle, safety barriers shall be used on all bridges. The requirement for safety barriers on bridges is addressed in section 3.4.

Retaining walls are similar to bridges in that they have no deformation space behind the safety barriers, are edged by a sheer drop and that the barriers are anchored in the wall. Safety barriers on retaining walls must therefore be treated like barriers on bridges. In locations where a falling terrain/precipice is combined with a retaining wall, consideration must be given to the side slope's overall height and any hazards that a vehicle might impact if it leaves the road.

Gradients steeper than 1:1.5 are considered to be precipices in this standard (see section 2.3). The need for safety barriers at precipices or on retaining walls is determined by the requirements in Table 2.7 in section 2.3.

2.10 Requirements for minimum distances for safety barriers

2.10.1 Minimum distances between safety barriers on roads with median safety barriers

On new national main roads with median and roadside safety barriers, the distance between the barriers shall be a minimum of 5.75 m. On other new roads that have median and roadside safety barriers, the distance between the barriers ought to be 5.75 m where the AADT ≥ 4000 and 5.25 m where the AADT < 4000 . On existing roads, or new roads with reduced standard in relation to the requirements in Manual 017, and where median barriers are installed, the distance between median and roadside safety barriers shall be a minimum of 5.25 m.

2.10.2 Minimum gap between safety barriers in the longitudinal direction

If the distance between the working part of two safety barriers (i.e. exclusive of tapered end sections, anchoring or energy absorbing terminals) is less than 100 m, the safety barriers shall instead be made continuous unless the gap is necessitated by an exit road, junction etc. This will be a safer and often financially more reasonable solution than protecting both barrier terminals.

2.10.3 Minimum distance between the carriageway edge and the safety barriers

Safety barriers shall be installed so that their traffic face is flush with the surfaced road shoulder's outer edge (road edge) to avoid an edge (difference in height) on the road shoulder.

On roads with a speed limit ≤ 80 km/h, the distance between the carriageway edge and the safety barrier's traffic face shall be a minimum of 0.5 m.

On roads with a speed limit > 80 km/h and AADT < 12000 , the distance between the carriageway edge and the safety barrier's traffic face shall be a minimum of 0.5 m.

On roads with a speed limit > 80 km/h and AADT ≥ 12000 , the distance between the carriageway edge and the safety barrier's traffic face shall be a minimum of 0.75 m.

2.11 Protecting other road users etc.

In addition to the need to protect drivers and passengers in errant vehicles, there will in certain situations also be a need to protect road users in adjacent traffic areas or other public areas near the road, against errant vehicles. These are discussed below.

2.11.1 Foot paths and cycle tracks along a road

Please refer to section 3.7 Safety barriers for pedestrians and cyclists.

2.11.2 Parallel roads

Where there is a road parallel to the priority road with a speed limit equal to 70 km/h or more, safety barriers must be installed against the parallel road if the AADT on the parallel road is 1500 or more and the distance from the priority road to the parallel road (between carriageway edges) is less than the safety zone width.

For priority roads with speed limits equal to 60 km/h or lower, the need for safety barriers is subject to individual consideration based on the local conditions.

2.11.3 Railway and metro lines etc.

If there are railway or metro lines within the safety zone, safety barriers must be erected. For safety zone width requirements, see 2.2.6, and for railway line safety barrier requirements, see 3.3.4 and Table 3.1 Selection of containment classes for safety barriers.

The Norwegian National Rail Administration's requirements for protective barriers at junctions are described in Chapter 10 of Manual 268 Bridge parapets (*Brurekkverk*).

2.11.4 Areas where people congregate etc.

It may be appropriate to protect other areas than those mentioned above against errant vehicles, for example, playgrounds, day-care centres, schoolyards, parking areas, camping sites, residential areas etc. The safety zone requirements have been made more stringent for places where people congregate, see section 2.2.7.

2.11.5 Safety barriers for worksites on roads

In accordance with Manual 051 Work on and along roads (*Arbeidsvarsling*), the purpose of securing the area between the worksite against road users by means of physical installations is to:

- Prevent workers and equipment from being impacted
- Prevent road users from impinging on the work area, and thereby causing serious damage/injury
- Limit the road users' injuries should they collide with the protective installations

It is important that protective equipment is used in a correct manner, since its misuse could lead to major and unforeseen consequences with respect to the safety of workers and road users.

3 Criteria for selection of safety barriers

3.1 Basic performance requirements

The safety barrier's primary objective is to contain errant vehicles in a controlled way and redirect the vehicle in a small angle back towards the carriageway or along the barrier until it stops. Damage to the vehicle and safety barriers ought to be limited as far as possible. It should be simple to replace damaged parts of the barriers. Significant parts of the safety barriers must not loosen or be thrown off to the side in a collision to reduce the risk of injury to people in the vicinity of the impact. See also 3.3.5.

The shape of the roadside area has the same purpose. A levelled verge may entail that the vehicle ends up a long way from the road and outside the safety zone. This can be very unfortunate for vehicles and the people travelling in them. In locations where there is a hazardous roadside obstacle just outside the safety zone, consideration ought to be given to installations that might catch errant vehicles.

Different types of safety barriers are divided into performance classes based on these parameters

- Containment classes T1, T2, T3, N1, N2, H2, H4, L2, L4
- Working width W and dynamic deflection D that express the barrier's stiffness
- Impact severity classes A, B and C

3.2 Selection of safety barrier type

3.2.1 General

The criteria for selecting a safety barrier type include the barrier's defined containment class, working width or dynamic deflection and impact severity class.

These values are obtained from the tests undertaken to secure approval of the safety barriers and are declared by the supplier.

In addition, financial, environmental, maintenance-friendly and aesthetic aspects play a role in the selection from the alternatives that satisfy the basic requirements. In certain circumstances, traffic safety over and above the approval requirements ought to be a point of consideration.

3.2.2 Containment classes

The basis for the selection of containment classes is the road speed limit (see section 1.9), the traffic volume and the shape of the roadside terrain. Normally, safety barriers designed for passenger cars (N1 and N2) are used, since passenger car collisions are the most common. However at special locations, where the runoff of larger vehicles from the carriageway will result in serious consequences, safety barriers of higher containment class (H2 or H4) are used.

Containment classes for safety barriers are selected based on Table 3.1. These are the minimum requirements. Higher containment classes can be used in special cases.

Containment class	Road conditions
T1	<ul style="list-style-type: none"> • Temporary situations, e.g. by roadwork areas with a temporary speed limit ≤ 50 km/h
T2	<ul style="list-style-type: none"> • Temporary situations, e.g. by roadwork areas with a temporary speed limit of 60 or 70 km/h
T3	<ul style="list-style-type: none"> • Temporary situations such as roadwork areas with a speed limit ≥ 60 km/h, a high traffic volume AADT > 4000 and a large proportion of heavy traffic > 20% • Temporary situations on roads with a speed limit of ≥ 70 km/h and with a high traffic volume AADT > 4000 • Temporary situations on motorways • Temporary situations on roads where the impact of a vehicle driving off the carriageway or through the safety barriers would involve particularly serious consequences for others. Signs ought to be erected for speed limits ≤ 60 km/h.
N1	<ul style="list-style-type: none"> • Speed limit ≤ 60 km/h and AADT ≤ 12 000 • Speed limit ≥ 70 km/h and AADT ≤ 1 500
N2	<ul style="list-style-type: none"> • Speed limit ≤ 60 km/h and AADT ≤ 12 000 • Speed limit ≥ 70 km/h and AADT > 1 500 • By retaining walls and precipices (gradients steeper than 1:1.5) that are higher than 1.5 – 4m* • For bridges and culverts with lengths ≤ 4 m and an AADT < 1 500* • On motorways
H1	<ul style="list-style-type: none"> • On narrow medians < 2 m on motorways and other roads with high speed levels > 80 km/h
H2 or L2	<ul style="list-style-type: none"> • On bridges and retaining walls higher than 4 m • By precipices (gradient steeper than 1:1.5) higher than 4 m or by water deeper than 0.5 m • On narrow medians < 2 m on motorways and other roads with high speed levels > 80 km/h and a high proportion of heavy traffic > 20%) • Locations where consequential damage/injury will be significant, e.g. next to water reservoirs, railways, metro lines, tunnels, fixed obstacles etc., collision with large fuel tanks etc.
H4 or L4	<ul style="list-style-type: none"> • On or under bridges where there is danger of serious damage to the bridge’s load bearing structure which upon collapse of the bridge could entail danger for many other road users etc. • Special locations on the motorway and other roads with high speed levels > 80 km/h and a high proportion of heavy traffic > 20%, where the risk of driving off the road is greater than usual or where the consequences of driving off the road would be particularly significant. • On bridges that cross high-speed railways, and along roads where high-speed railways lie within the safety zone
Tunnel	<ul style="list-style-type: none"> • Safety barriers in tunnels are not deformable

* Conditional upon there being adequate safety barrier deformation space. Temporary barriers are permitted only as replacements for N1 or N2. The L classes shall be used where possible.

Table 3.1 Selection of containment classes for safety barriers

There are specific terminal requirements for all types of safety barriers, see Chapter 4.

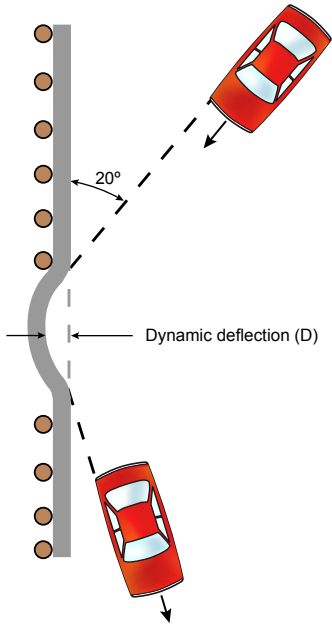

Figure 3.1 Illustration of a crash test for safety barrier deformation

3.2.3 Dynamic deflection and working width

Upon impact, the safety barriers will bend. The barrier's working width (W) is the maximum horizontal distance between the safety barrier's traffic face before impact and its rearmost point under impact. The safety barrier's dynamic deflection (D) is the horizontal distance between the barrier's rear face before and after impact.

Figure 3.1 illustrates a crash test with bending of the safety barrier, Figure 3.2 shows the safety barrier's dynamic deflection (D), working width (W) and the vehicle intrusion (VI).

For large vehicles, special requirements may apply with respect to the width of the area outside the safety barrier and clearance above the vehicle on impact (because the vehicle will roll and tip over on one side upon impact). For high roadside obstacles, the possible roll of large vehicles must be taken in consideration, see Figures 3.2 e and f). If the vehicle rolls farther than the deformed safety fence, the vehicle intrusion (VI) shall be reported. VI is the maximum distance between the safety barrier's front edge before impact and the vehicle's rearmost point during the impact, including any roll. See also section 2.2.10.

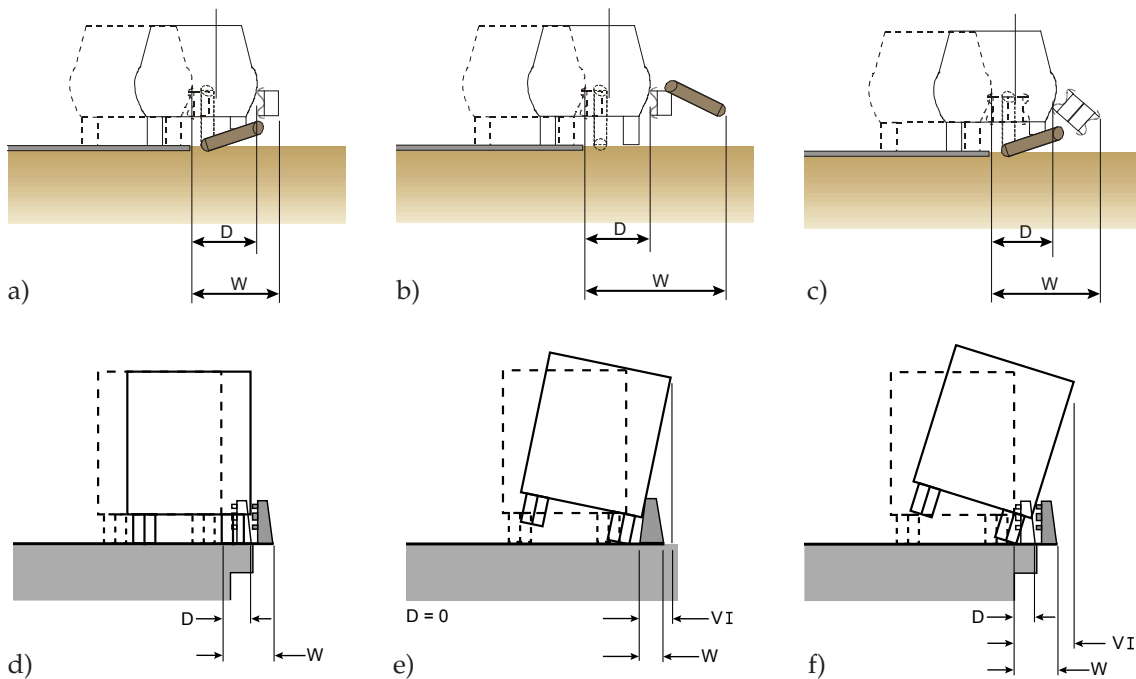
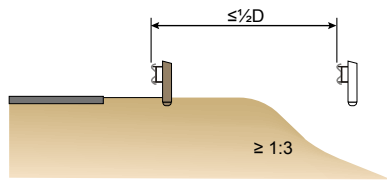
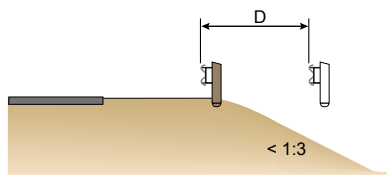

Figure 3.2 Working width (W), dynamic deflection (D), VI vehicle intrusion



a) Dynamic deflection (D) on falling gradients of 1:3 or steeper (does not apply for bridges, retaining walls and shear drops).



b) Dynamic deflection (D) on falling gradients of 1:3 or gentler.

Figure 3.3 Example of dynamic deflection (D) on slopes

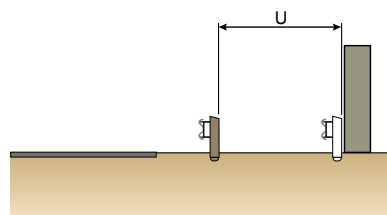

a) Deflection space (U) by hazardous roadside obstacle.

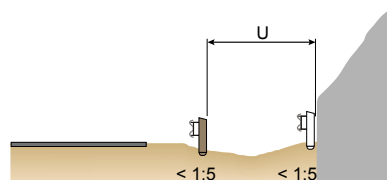

b) Deflection space (U) by road with ditch/slope with falling gradient of 1:5 or gentler towards rock cut.

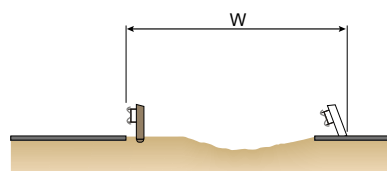

c) Working width (W), dynamic deflection (D), VI vehicle intrusion.

Figure 3.4 Examples of the necessary width behind safety barriers at hazardous roadside obstacles, footways and cycle tracks

There must be adequate space for the dynamic deflection behind the safety barrier (see Figures 3.3 and 3.4) The following rules provide a basis for calculating sufficient width behind safety barriers in different situations (in all instances, the width must be sufficient to ensure satisfactory anchoring for the barrier posts - see 5.2.6):

- For bridges, retaining walls and shear drops, D is not permitted to extend more than 20 cm beyond the bridge or wall edge, or 40 cm beyond the vertical angle point for shear drops.
- For slopes with a falling gradient of 1:3 or steeper, a maximum of half the safety barrier's dynamic deflection may extend beyond the top of the slope (see Figure 3.3 a)
- For slopes with a falling gradient which is gentler than 1:3, the safety barrier's full dynamic deflection may extend beyond the top of the slope (see Figure 3.3 b)
- In front of hazardous roadside obstacles, the safety barrier's working width (W) may not extend beyond the available displacement space (U) (see Figures 3.4 a and b)
- For footways and cycle tracks (f/c), see 3.7.3

The safety barrier's dynamic deflection D or working width W established by the test, may be reduced by 50% at these speed limits:

- for safety barriers in strength classes T1, T2 and T3 at speed limits ≤ 50 km/h
- for safety barriers in strength class N1 at speed limits ≤ 60 km/h
- for safety barriers in strength class N2 at speed limits ≤ 60 km/h
- for safety barriers in strength classes H2/L2 at speed limits ≤ 50 km/h

For slopes with a falling gradient of 1:5 or gentler, the safety barriers are permitted to be placed on the slope. For slopes with a falling gradient of 1:3 to 1:4, permission is given under some conditions to place the safety barriers down on the slope (see 4.6.3). The safety barriers must, in this case, be tested and approved for such positioning.

NS EN 1317-2 divides safety barriers into classes according to working width (W). These are given in the table 3.2.

W-klasse	W1	W2	W3	W4	W5	W6	W7	W8
Working width (m)	≤ 0,6	≤ 0,8	≤ 1,0	≤ 1,3	≤ 1,7	≤ 2,1	≤ 2,5	≤ 3,5

Table 3.2 Working width (W), values in metres

The values for D and W are specified in a list of safety barriers for use on county and national roads in Norway posted by the Directorate of Public Roads at www.vegvesen.no.

3.2.4 Impact severity

The forces which drivers and passengers are exposed to on impact with safety barriers are, to a large degree, decisive for the extent of their resulting injuries. These forces are in this context expressed by ASI and THIV, see section 1.8. The impact severity is defined in three classes: A, B and C depending on the stiffness of the safety barrier.

Impact severity class A has the lowest ASI value and therefore represents a risk of minimal personal injury. However, classes A and B entail relatively little risk of serious personal injury. Class C for structures and cast in-situ safety barriers has a higher risk of injury and ought therefore to only be used where there are no good alternatives to safety barriers in impact severity classes A or B.

3.2.5 Aesthetics

Safety barriers are visible visual elements in the physical environment.

The selected safety barriers must be sympathetic to the surroundings, and special requirements apply with respect to architectural design, especially in urban and densely populated areas. Customised safety barriers (those that are not type approved) must be approved for use on Norwegian roads.

In general, safety barriers that obscure road visibility as little as possible are preferable. This especially applies to viewpoints, roundabouts and exit roads. In areas where there is a risk of being dazzled by oncoming headlights, special consideration should be given to whether transparent safety barriers are desirable.

Emphasis should be given to an aesthetically pleasing safety barrier design in areas where there are pedestrians and cyclists. Safety barriers along roads and streets ought to follow the road alignment and be terminated in a visually logical manner, as well as meet the safety requirements. The colours selected for the safety barriers should ensure that they do not stand out against the surroundings.

Alternatives to safety barriers can, in many cases, be the better solution, aesthetically, financially and in terms of traffic safety. Examples of good alternatives to safety barriers include earth embankments or clearing the roadside of hazardous obstacles.

3.2.6 The environment

When selecting safety barriers, both lifespan and environmental assessments shall be carried out.

Special consideration should be given to the following environmental aspects:

- Whether the safety barriers will entail undesirable noise reflection in densely populated area
- The environmental impact of materials used ought to be as low as possible in production, when in use and upon destruction
- Long, impenetrable safety barriers in areas with vulnerable fauna should be avoided because the safety barriers will represent a barrier for small animals and amphibians
- Safety barriers ought to be selected based on the various weather conditions at the location, e.g. wind, level of snow etc.

3.2.7 Maintenance of safety barriers

When selecting safety barriers, emphasis shall be placed on rapid, problem-free acquisition of spare parts. Damaged safety barriers and crash cushions could represent a traffic hazard and are to be repaired as soon as possible. If one type of safety barrier requires more maintenance than another, this shall be considered as part of the barrier selection assessment. Safety barrier suppliers shall establish the probability of rapid spare part availability (not more than 1 week is suggested).

See also Manual 111 Operation and maintenance (*Standard for drift og vedlikehold*) and Manual 267 Standard safety barriers (*Standard vegrekkverk*).

3.3 Road safety barriers

3.3.1 General

The safety barrier type is selected based on criteria such as containment class, impact severity class, dynamic deflection (D) and working width (W). These are limited by the displacement space (U) available, i.e. the distance from the safety barrier's back edge to the hazard (see Figure 1.5).

Soft safety barriers reduce the probability of personal injury and will cause less damage to vehicles than equivalent, stiffer types. They ought therefore to be selected where there is adequate displacement space (U) behind the barriers. Stiff/rigid safety barriers must be used where there is restricted displacement space (U) behind the barriers.

Detailed drawings of the Norwegian Public Roads Administration's standard road safety barriers are provided in separate guidelines, Manual 267 Standard road safety barriers (*Standard vegrekkverk*). For other types of safety barriers, please refer to the supplier's drawings and descriptions.

3.3.2 Safety barrier requirements

Safety barriers must always be installed according to the supplier’s instructions.

The height of the centre of the safety fence beam shall be 600 ± 20 mm above the surface of new roads.

For existing roads, the height of the centre of the safety fence beam shall be 600 ± 50 mm above the asphalt surface, and the height to the top of the beam shall be 750 ± 50 mm above the asphalt surface. Concrete safety barriers shall have a minimum height above the asphalt surface of 800 mm.

If the verge has significant height variations, a tolerance of ± 100 mm may be added to the above mentioned heights. For other tolerances, reference is made to section 75.2 of Manual 025 Specifications 1 (*Prosesskode 1*).

Safety barriers must always be secured with adequate anchorages or foundations so that the barriers will be able to perform as intended.

Safety barriers must always start and end in such a way that they do not represent a risk of personal injury. See section 4.3.

3.3.3 Earth banks as a safety barrier replacement

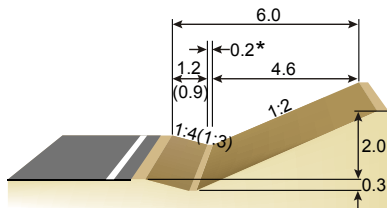

a) side slope gradient 1:2

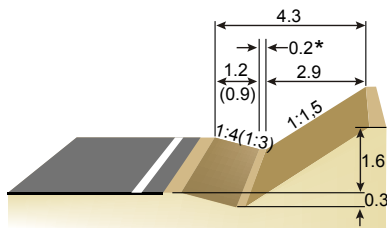

b) side slope gradient 1:1.5

A good alternative to installing safety barriers on downward sloping terrain, is to build up an earth bank. To prevent vehicles from driving onto the bank, it shall be shaped as shown in Figure 3.5.

Where the earth bank gradient is 1:2 (see Figure 3.5 a), the back-side slope height (h) above the carriageway level must be minimum 2.0 m.

Where the back-side slope is 1:1.5 (see Figure 3.5 b), the slope height (h) above the carriageway level must be minimum 1.6 m. To achieve a stable slope of 1:1.5, special material must be used, see Manual 018 Road construction (*Vegbygging*).

Figure 3.5 Minimum requirements for banks built against downward sloping terrain.

3.3.4 Safety barriers along railways

Where there is an ordinary railway within the safety zone, H2 safety barriers shall be used. Where there is a high-speed railway within the safety zone, H4 safety barriers shall be used.

The safety barrier height must be 1.2 m if the railway is within the first half of the safety zone’s width or if the railway is on a level lower than the road. Safety barriers shall always be 1.2 m high for high-speed railways. Where 1.2 m high safety barriers are not required, 0.75 m high barriers may be used.

The distance to the railway is measured to the middle of the closest track.

3.3.5 Special regulations for certain types of safety barriers

The use of some types of safety barriers is subject to restrictions. Such restrictions shall be stated in the letter of approval.

Wooden posted safety fence cannot be used closer than 25 m to other footways/cycle tracks, roads/metro lines/railways or roadside public areas without special measures. In case of a high-speed collision, large parts of the posts on a wooden post fence can loosen and be thrown several metres to the side. This requirement does not apply if the wooden post is encased in plastic, see Manual 267.

3.4 Safety barriers and parapets on bridges, retaining walls and at precipices

3.4.1 General

Bridge parapets are safety barriers designed for bridges, retaining walls and at precipices that are higher than 4 m (see Table 3.1). Bridge parapet containment classes are defined in Table 3.1. Geometrical parameters are described in 3.4.3.

According to Table 3.1, bridge parapets in containment classes H2/L2 are normally used on bridges, retaining walls and at precipices. H4 is used where penetration of the parapet would have serious consequences for others, beyond injury to people travelling in the vehicle and damage to the vehicle.

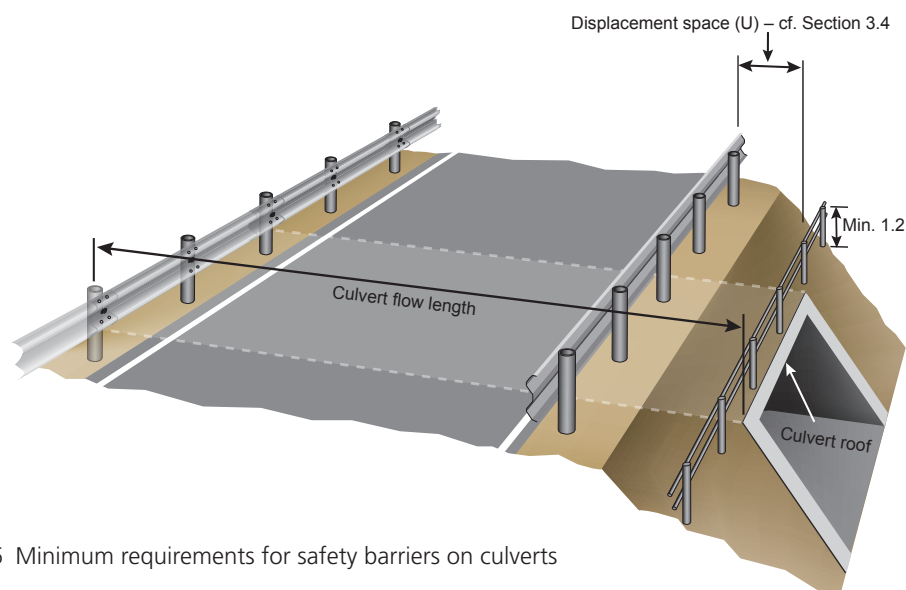

Figure 3.6 Minimum requirements for safety barriers on culverts

Reference is made to the supplier's drawings and descriptions with regard to the installation of the parapets. Drawings for the Norwegian Public Roads Administration's standard bridge parapets are shown in separate guidelines, Manual 268 Bridge parapets (Brurekkverk). Manual 268 also contains more detailed requirements for bridge parapets, including requirements for materials and the Norwegian National Rail Administration's requirements for protective barriers.

Parapets shall be designed to satisfy all visibility requirements (see Manual 017). Parapets can appear very solid and prevent good visibility when viewed at a sharp angle. This will also apply to posts on ordinary safety barriers.

Bridge plans shall contain solutions to transitions between bridge parapets and road safety barriers. This is to ensure that there is a satisfactory connection between parapets and barriers. Transitions shall ensure a gradual increase in stiffness from the safety barriers to the bridge parapets.

Bridge parapets can be replaced with safety barriers in containment class N2 for bridges and culverts with lengths ≤ 4 m and an AADT < 1500 , for example agricultural crossings, and retaining walls with heights from 1.5 to 4 m. Bridge parapets can be replaced by low H2 barriers for bridges and culverts with lengths ≤ 5 m and an AADT < 4000 . In the above cases, adequate deflection space (D) is required behind the safety barriers. Where N2 safety barriers are used on a culvert, the culvert's outer edge and top of the retaining wall shall be secured with a fence or similar (see Fig. 3.6). The same applies when there is an accessible strip of land between the road, or bridge parapets to the edge of the precipice. The safety barrier/parapet is intended to prevent falls and incidents, and shall tolerate large amounts of snow. In situations where slopes/precipices are combined with retaining walls, consideration must be given to the slope's total height and any hazards that a vehicle might hit.

In other locations where the Norwegian Public Roads Administration has intervened, for example at tunnel portals that are open to access from the road and where drops are ≥ 4 m, a safety fence must be erected. Where a sign prohibits walking or cycling on the road, a safety fence is not necessary.

3.4.2 Bridge parapet requirements

Bridge parapets shall be erected as tested. The manufacturer and/or supplier shall describe the parapet's anchoring system, see also 3.4.5.

See also 3.2.3 dynamic deflection and working width, as well as the lifespan of bridge parapets (section 5.1).

Bridge parapets for pedestrians and cyclists

Footways/cycle track bridge parapets are safety barriers used on separate footways/cycle tracks. Footway/cycle track bridge parapets are permitted for use on road bridges that have a safety barrier with a prescribed containment class between the road and separate footways/cycle tracks. Footway/cycle track safety barriers continue past the end of the bridge and are terminated so that vulnerable road users are in no danger of falling outside the road by abutments and injuring themselves.

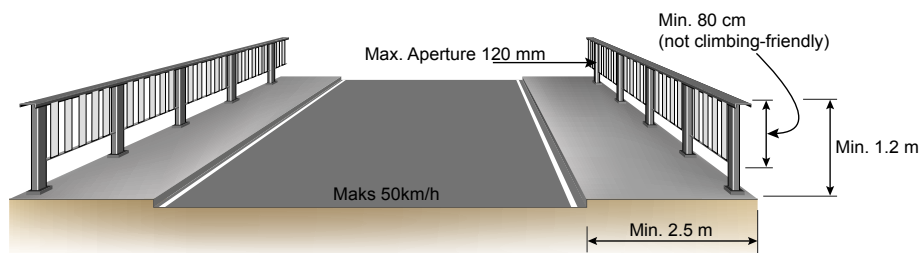

Figure 3.7 Minimum requirements for urban bridge parapets

Bridge parapets in towns

Parapets for town bridges can be installed where the speed is a maximum of 50 km/h, where there is an elevated pavement, and where the pavement is at least 2.5 m wide (see Manual 017).

The parapets must be at least 1.2 m high above the pavement level and have apertures not greater than 120 mm. The parapets must not be climbing-friendly, to ensure that small children cannot easily climb over them. Bridge parapets in towns can be without safety fence beams where they are anchored to the pavement and where the speed limit is ≤ 50 km/h. However, they must be designed for impacts without the rail. This may also apply to other places than in towns.

Test requirements for town bridge parapets are different from the test requirements in NS EN 1317, see section 1.6.

The termination of safety barriers with guardstones is only permitted in connection with pavements that are wider than 2.5 m where the greatest permitted speed is 50 km/h.

Parapets on bridges across railway lines

On road bridges that cross over railway lines, the bridge parapet is installed in addition to the protective railway barriers required by the Norwegian National Rail Administration, see Manual 268.

On bridges that cross high-speed railway lines, parapets of containment class H4 must be used. On bridges that cross ordinary railway lines, parapets of containment class H2 must be used. Consideration should be given to using H4 parapets even across ordinary railway lines if there is high speed and/or high density of trains at the location.

Inner safety barriers on bridges

Inner safety barriers shall be used on bridges and retaining walls where safety space is required or a footway/cycle track is running on the outside. On roads with speed limits/speed levels ≤ 60 km/h, a pavement with a minimum height of 12 cm is adequate.

On roads with speed limits of 60, 70 and 80 km/h, it is permissible for the safety barrier's working width W to cover up to 0.6 m of footway/cycle track.

On roads with speed limits ≥ 90 km/h, footways and cycle tracks are not permissible within the safety zone without a safety barrier in between. If the footway/cycle track must be located within the safety zone, the safety barrier's working width (W) must be less than 0.6 m, and must not intrude on the footway/cycle track

Outer safety barriers on bridges

Outer safety barriers are bridge parapets mounted on the outer side of the bridge. These are usually H2/H4 (L2/L4) parapets, see Table 3.1 If H2/H4 (L2/L4) safety barriers are used as inner barriers, the outer parapets can be footpath safety fences, see section 3.4.5.

Median safety barriers

Median safety barriers are the barriers that divide the carriageway. If the road consists of separate, parallel bridges where it is possible for a wheel to get down between the bridges, median safety barriers must be H2/H4. If the road has a bridge with median barriers, these may be normal median safety fences subject to the appropriate rules, see sections 2.2.9 and 2.7. In cases where median safety barriers on bridges are an extension of the median safety barriers off the bridge, maintenance openings shall be located on both sides of the bridge so that traffic can pass on one half of the bridge while bridge maintenance takes place.

Snow clearance fences

Snow clearance fences should be installed on bridges over roads and walls above public areas where the impact of ice/snow blocks, falling from the road on facilities and people, may be severe, see section 3.4.3. For road going over portals, snow clearance fences are not required when the distance to the edge of the portal is > 5 m.

3.4.3 Geometrical bridge parapet requirements – outer parapets

Parapet heights and tolerances

The minimum height of bridge parapets is 1.2 ± 0.025 m, measured from the bridge surface course, pavement or footpaths and cycle track to the top of the outer parapet or footpath/cycle tracks

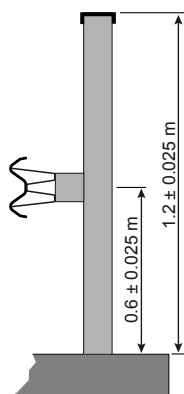

Figure 3.8 Bridge parapet heights

parapet,. Inner parapets may be exempt from this requirement. The height of the centre beam above the carriageway shall be 0.6 ± 0.025 m. The posts shall have a maximum deviation of ± 0.025 m in relation to the vertical line. For other tolerances, reference is made to section 87.2 of Manual 026 Procedure 2.

On bridges that, from experience, people will jump from, the parapets must be at least 1.6 m high, have a vertical balustrade that is minimum 1.4 m high and impossible to use as a ladder or other device with the same function, and incline inwards 10-12 degrees. The top of the handrail shall be rounded so that it is difficult to grasp. This applies especially to bridges in areas near towns that are high enough for jumps with a probable fatal outcome.

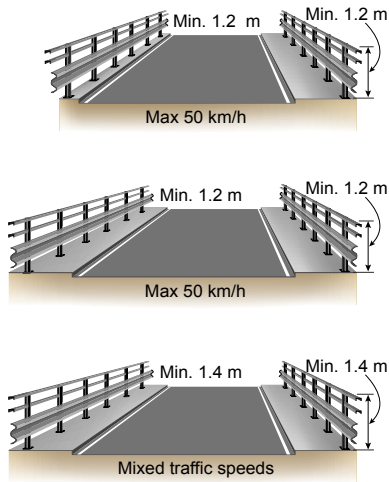

Figure 3.9 Minimum parapet requirements for bridges with pedestrian traffic

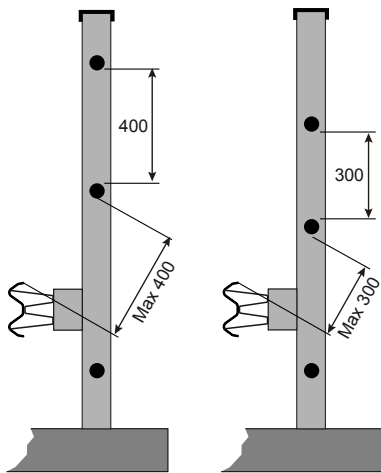

Figure 3.10 Aperture requirements for parapets on bridges without pedestrian traffic

minimum aperture between two neighbouring elements, see Figure 3.10. If there is a “No Pedestrians” road traffic sign, this opening can be increased to 400 mm. Where parapets are used on bridges with pedestrian access whether with or without delimited foot paths and cycle tracks or pavements, this opening shall not be larger than 120 mm.

Where snow clearance fences are needed, the opening shall not be larger than 50 × 50 mm.

Length of bridge parapets beyond the bridge

Parapets on bridges or retaining walls must not transition to safety barriers before the rear end of the bridge abutment or the top of the slope + 2 m. They must then be anchored or fastened via a transition to a road safety barrier.

On bridges with combined pedestrian and vehicular traffic without separate footpaths/cycle tracks, increasing the height of the parapet above 1.2 m should be considered, depending on the amount and type of pedestrian or cycle traffic. On bridges where it is likely that small children will be without supervision, and where the bridge is on a school route, wall panel heights of 0.65 m (i.e. 1.4 m total height) that are not climbable ought to be used. Bridges with significant pedestrian traffic ought to have a separate foot path/cycle track with a physical divide (vehicle-proof inner safety fences) and footpath/cycle track-safety barriers as outer barriers.

For outer parapets where the lower part consists of concrete and the upper part of e.g. steel, the concrete barrier must have a normal height of at least 0.8 m. Higher concrete parts can be considered based on conditions at the location. Lower amounts of concrete can be considered if the combination of concrete plus the top beam is tested, see section 1.6. The combination of the different barrier parts must be approved.

Distance to the outer edge of the bridge

The distance from the outer element of the parapet to the outer edge of the bridge must be a maximum of 200 mm to reduce the possibility of climbing on the outside of the parapets.

Apertures in the parapets

Apertures in the parapets on bridges without pedestrian traffic must be smaller than 300 mm, measured as the

Edge beams

Generally, bridges ought to have edge beams for drain control and to prevent hazardous obstacles from falling down on underlying areas, resulting in damage or injuries, see Manual 268. This may be left out where water can drain directly over the edge of the bridge without resulting in problems under the bridge.

3.4.4 Bridge parapet strength requirements

Bridge parapets must satisfy the containment class requirements set out in Table 3.1. Full-scale testing is usually carried out in accordance with NS EN 1317. For testing of urban bridge parapets and custom-made systems, see section 1.6. The following strength requirements apply to panels etc. that have not been included in the testing.

Panels etc. that have not been included in the testing must not affect the parapet's performance, or represent a danger to road users.

Loads on panels and balustrades

Panels and balustrades are designed to bear a load of 1.2 kN/m² evenly distributed over the panel's surface. Balustrades between horizontal profiles are inspected for a point load of 0.5 kN in the most unfavourable position. The perpendicular load direction to the safety barrier plane is checked, as well as the perpendicular load direction to the balustrade in the barrier plane.

Loads on panels and balustrades are treated as traffic loads and therefore designed in the failure limit state. Panels and balustrades must not be constructed to allow penetration of vehicles and personal injury in case of an incident.

Loads on the horizontal parts of safety barriers

Horizontal profiles between safety barrier posts are designed to distribute evenly a horizontal load of 1.2 kN/m over each individual profile length. The load is not expected to occur on several profiles simultaneously. In addition, the profiles must be inspected for a point load of 1.5 kN in the most unfavourable position.

Loads on profiles are treated as traffic loads and therefore designed in the failure limit state. In an incident, horizontal profiles must not penetrate vehicles, possibly by loosening, and injuring passengers.

Loads on the handrails

All bridge parapets are made with handrails. Where handrails are not a structural part of the parapet, or do not provide support for anyone, they can be omitted (for example concrete parapets 1.2 m high on a road without pedestrian traffic).

When the handrail is an integrated part of the bridge parapet, it must be included in the physical tests or simulations. When handrails are not part of the bridge parapet's structure and are added as an extra, the handrails must be calculated as described below and must not affect parapet's performance.

To ensure a minimum strength, the handrail must be designed for a linear load in horizontal and vertical directions of 1.5 kN/m in the failure limit state. The loads do not occur simultaneously. This applies to both non-deformable and deformable bridge parapets.

The lengths of handrail must be joined to avoid dangerous situations in impacts. The following requirements must therefore be met:

1. The relationship between the installation joint's elastic capacity and the full cross section's capacity (axial, bending and shear) must be at least 0.8.
2. The relationship between the expansion joint's elastic capacity and the full cross section's bent and shear capacity must be at least 0.8.
3. The fastening of the handrail to the post must have a capacity equivalent to 1.5 times the force that gives simultaneous movement in the post's lengthwise and crosswise directions.
4. When applying the characteristic linear loads, deformation of the handrail must not exceed 10 mm in a horizontal direction and 5 mm in a vertical direction.

Parapets on temporary bridges and ferry terminal bridges

On temporary bridges where the speed limit is ≤ 50 km/h, and on ferry terminal bridges, the parapets shall tolerate 35 kN/m over 4 m in the most unfavourable position normally loaded on the parapet and on the centre rail (600 mm) which is static. In addition, the handrail shall be loaded as described in 3.4.4. Calculations are made for the failure limit state.

If the speed is over 50 km/h, ordinary, type-approved parapets are to be used.

3.4.5 Strength requirements for the parapet's underlying structure

Collision loads that are transferred via bridge parapets to their underlying structures are described in NS EN 1991-2:2003 (4.7.3.2 and 4.7.3.3) and "National Annex". For (worldwide) design of bridge decks, the following horizontal and vertical loads are used:

- Horizontal load transferred via bridge parapets
 - For steel parapets, class A (100 kN) is used for H2/L2 parapets and class B (200 kN) for H4/L4 parapets. [NS EN 1991-2:2003, 4.7.3.3 (Note 1)]
 - For rigid concrete parapets, class B (200 kN) is used for H2/L2 parapets and class C (400 kN) for H4/L4 parapets [NS EN 1991-2:2003, 4.7.3.3 (Note 1)]

In addition, there is the vertical load that affects the bridge deck simultaneously with the above mentioned horizontal load [NS EN 1991-2:2003, 4.7.3.3 (Note 3)].

The vertical load is an axle load. The load is placed against the parapet that is impacted.

Design load effects for local loads (the posts' anchoring to the bridge surface) are calculated by multiplying the post's nominal capacity by a factor of 1.5 (for 355 steel) and 1.7 (for 235 steel). This factor covers both variations in steel quality and fastening (the capacity increase of the material after the steel goes over into the non-elastic area). [NS EN 1991-2:2003, 4.7.3.3 (Note 2)].

NS EN 1991-2:2003 subsection 4.7.3.3 (2) states "1.25 times the bridge parapet's characteristic local capacity". Characteristic capacity means the parapet post's real capacity. This is included in the above mentioned factors.

The load effect of the horizontal impact force is distributed at 45° into the concrete parapet and the concrete deck. From a steel parapet, it is distributed over two posts down to the concrete deck and thereafter at 45° into the concrete.

- For horizontal loads on the kerb/edge beam, 100 kN is used, plus a vertical load as described (NS EN 1991-2:2003, 4.7.3.2). This load does not occur simultaneously with the above mentioned load on the parapets. The load is not used in cases where the bridge deck has no edge beams.

The purpose of these impact loads is to ensure that underlying structures are designed to take the loads without being damaged to any mentionable extent.

3.4.6 Loads on expansion joints

The expansion joints in deformable safety fences at bridge joints, shall have the same opportunities for movement as bridge joints. Special consideration must be given to expansion joints in curves, since these can get displaced both along and across the bridge. Expansion joints must have the same strength as the rest of the safety barriers.

Rigid concrete barriers can be continuous on bridges that do not have expansion joints.

3.5 Safety barriers in Tunnel

Approved safety barriers must be used in tunnels. Containment classes for safety barriers are selected based on Table 3.1.

3.5.1 Tunnel portal safety barriers

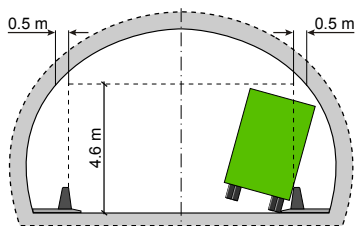

Figure 3.11 Overhead safety zone

Safety barriers at tunnel portals must have overhead safety zones above the tunnel road space if the speed limit > 60 km/h and AADT > 1500, see Figure 3.11. The overhead safety zone is as shown in 2.2.10. Safety barriers go 20 m into the tunnel portal and are thereafter bent in towards the portal wall or rock face at an angle of 1:10 before being fastened to the wall. This applies whether the portal has parallel walls or is shaped like a funnel.

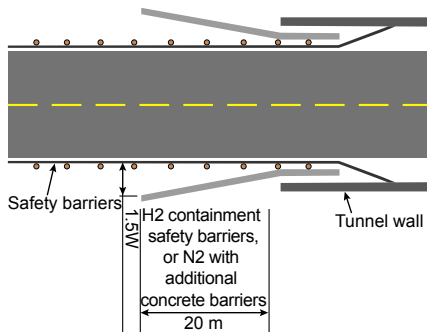

Figure 3.12 Schematic diagram of the placement of safety barriers before parallel tunnel portals

The safety barrier containment class for parallel tunnel portal walls, should generally be the same as before the tunnel. However, the safety barriers ought to be reinforced to H2 just before the tunnel, to prevent high, heavy vehicles from hitting the tunnel portal, see Figure 3.12. The length of the reinforced section shall be approx. 20 m long before the beginning of the tunnel portal (alternatively, N2 safety barriers can be used with concrete barriers on the back).

For trumpet shaped tunnel portals, the safety barrier's containment class shall be the same as before the tunnel. Reinforcement to H2 is not necessary here.

See Manual 021 Road tunnels (Vegtunneler).

3.6 Safety barriers and snowdrifts

Safety barriers can result in snow accumulating in greater volumes on the road. This can lead to an increased need for snow clearance, higher banks of snow and poorer visibility. In locations where there are large amounts of snow, for example along high mountain roads, emphasis ought to be placed on designing cross-section profiles and ditches that will avoid an accumulation of snow.

If possible, high embankment slopes ought to be made gentler to avoid the need for safety barriers. High banks of snow can be reduced by elevating the road over the terrain and giving it broad, rounded shoulders.

In places that are especially prone to snowdrifts, the use of special safety barriers that to a lesser degree cause the snow to collect on their lee side ought to be considered. This can for example be wire safety fences, pipe fences or steel safety fences with a narrow beam.

On high mountain passes, where snow clearance regularly causes damage to safety barriers, an alternative could be to use 4 mm thick beam.

See Manual 167 Snow protection (Snøvern) for detailed discussions with respect to the design of the road's cross-section profile, use of safety barriers and the problems arising from snowdrifts.

3.7 Safety barriers for pedestrians and cyclists

Safety barriers for pedestrians and cyclists are used along footpaths and cycle tracks where greater danger is associated with falling or cycling off the footpath/cycle track than with cycling into the barriers. Safety barriers intended for vehicles are not normally used for footpaths and cycle tracks; only on footpaths and cycle tracks that are open to vehicular traffic.

Guide fences for pedestrians and cyclists are defined in section 1.7, and are more closely discussed in Manual 017 Road and street design (Veg- og gateutforming).

There are special requirements for footpaths and cycle tracks along roadways. These requirements do not apply where there are pavements.

3.7.1 The need for safety barriers for pedestrians and cyclists

The following hazards ought to be secured with safety barriers if they lie within a distance of 1.5 m from footpaths and cycle tracks.

- high and steep side slopes – steeper than 1:3 and higher than 2 m
- precipices steeper than 1:1.5 and higher than 1 m
- rivers and lakes where the water depth is more than 0.5 m at high water.
- rock cuttings with dangerous, protruding parts
- other hazards, after further consideration

Safety barriers for pedestrians and cyclists are a type of barriers that is used in places where there usually is no motorised traffic (aside from for maintenance of the tracks or path). Where heavy maintenance vehicles (e.g. snow clearing equipment) will be able to cause great damage or injury, or cause secondary incidents on roads, railways, metro lines, water reservoirs etc., road safety barriers must be used.

On footpaths where mixed traffic is allowed, a road safety barrier should be erected (possibly higher road barriers in presence of high, steep slopes or precipices).

Safety barriers can also be used at locations where the division of a footpath and cycle track traffic from other traffic is desirable, for example to delineate footpaths and cycle tracks from parking areas and private driving areas that do not need such strong barrier systems.

When safety barriers are erected between roadways and footpaths and cycle tracks, attention must be paid to ensuring there are no sharp edges on the back side of the barriers that could entail personal injury in a collision.

An extra beam (perhaps a smaller beam) should be used on the backside of the safety fence posts where there is a need to protect pedestrians or cyclists against incidents on collision with the barriers. Other measures can be considered, but these must not change the behaviour of the safety barriers upon impact. See also section 3.8.

3.7.2 Geometry and strength requirements for safety barriers for pedestrians and cyclists

Safety barriers for pedestrians and cyclists must satisfy the strength and geometric requirements that are specified below.

Loads on posts

The posts shall absorb the forces that come from the structure between the posts. In addition, they should carry a normal linear load of 1.5 kN/m. Posts must also be checked for a point load of 1.5 kN in the most unfavourable position – both normally and along the safety barrier.

The handrail fastening to the post must have a capacity equivalent to 1.5 times the load that comes from the handrail. The posts' foundations shall be designed for a force that is 1.5 times the performance force.

Loads on handrails

The handrail must be designed for a linear loading in the horizontal and vertical directions of 1.5 kN/m in the failure limit state. The loads do not occur simultaneously.

The lengths of handrail must be joined in a proper manner so that performance loads are transferred by the joint. When applying the characteristic linear loads, deformation of the handrail must not exceed 10 mm in a horizontal direction, and 5 mm in a vertical direction.

Loads on panels and balustrades

Panels and mesh are designed to bear a load of 1.2 kN/m² evenly distributed over the panel's surface. Mesh between horizontal profiles are checked for a point load of 0.5 kN in the most unfavourable position – both normally and along the safety barrier.

Loads on horizontal parts of safety barriers

Horizontal profiles between safety fence posts are designed to evenly distribute the horizontal load of 1.2 kN/m over each individual profile length. The load is not expected to affect several profiles simultaneously. In addition, the profiles must be checked for a point load of 1.5 kN in the most unfavourable position – both horizontally and vertically.

Geometric requirements

Alongside slopes that are gentler than 1:1.5, open safety barriers with a height of 0.9-1 m can be used. Where the slope is higher than 1 m, and steeper than 1:1.5, the rear of the barriers ought not to lend themselves to climbing. The height should be 1.2 m and the maximum distance between vertical elements should be 120 mm.

Safety barriers for pedestrians and cyclists shall have handrails. To protect against damage or injury from snow clearance equipment, and to ensure that cyclists who fall will slide along the barrier, the barriers may also be fitted with a low-level beam.

The termination of footpath/cycle track safety barriers must be rounded and without sharp edges that could lead to personal injury. See also section 3.8.

All loads specified above are treated as traffic loads and therefore designed in the failure limit state.

3.7.3 Traffic divides between roadways and footpaths/cycle tracks

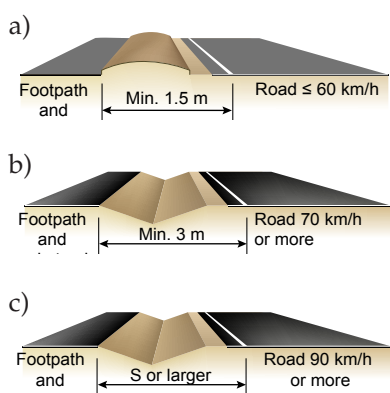

Figure 3.13 Minimum traffic divide without safety barriers between roadways and footpaths and cycle tracks

Where footpaths/cycle tracks run along roadways with a speed limit ≤ 60 km/h, there ought to be a traffic divide of at least 1.5 m between the carriageway edge and footpath/cycle track, see Figure 3.13. Where footpaths/cycle tracks run along roadways with a speed limit ≤ 60 km/h, there ought to be a traffic divide of at least 1.5 m between the carriageway edge and footpath/cycle track, see Figure 3.13. This solution is preferred. The verge should be limited by deflecting kerbstones for such small traffic divides. If the traffic divide is narrower, safety barriers or other physical traffic divides as defined in our lists shall be erected.

Where footpaths/cycle tracks run along roadways with a speed limit of 70 or 80 km/h, there ought to be a traffic divide of at least 3.0 m between the roadway and footpaths/cycle tracks (see Figure 3.13 b). This solution is preferred. Ditch slopes ought to be 1:5. The traffic divide ought to be prominent so that it is difficult to cross where footpaths and cycle tracks are defined as school routes. If the traffic divide is narrower, safety barriers shall be erected.

Along roadways with speed limits ≥ 90 km/h, footpaths/cycle tracks ought to be aligned outside the safety zone of the roadway, see Figure 3.13. If footpaths and cycle tracks are inside the safety zone, safety barriers must be erected, or an embankment constructed.

It may also be appropriate to erect safety barriers along footpaths/cycle tracks in special situations even if the traffic divide is wider than specified above. This could be, for example, in sharp curves where the risk of incidents is especially great or just outside school gates.

For roads with speed limits ≥ 90 km/h, the safety barrier's working width (W) is not allowed to extend into the footpath/cycle track in case of collision. For roads with speed limits of ≤ 80 km/h, the safety barrier's working width is permitted to cover up to a third of the footpath/cycle track width.

When footpaths/cycle tracks are lower than 1.0 m below the roadway, safety barriers shall be erected if the slope from the roadway to the footpath/cycle track is steeper than 1:4.

3.7.4 Protection of vulnerable road users

Today's safety barriers often represent a risk of injury to cyclists. The most serious incidents occur when the cyclist hits a sharp edge or a protruding part. Injury can also occur when cyclists hit hard safety barrier elements.

Where there is significant bicycle traffic, it can be appropriate to protect the back of the barriers with an additional beam. This especially applies to locations where there is an increased risk that cyclists will fall and injure themselves on the back of the safety barriers.

A top rail or a plastic hat on the top of the posts may also be used to protect vulnerable road users from injuring themselves on sharp edges should they fall against the guardrails. This is most relevant in locations with significant bicycle or horse traffic.

3.8 Protection of motorcyclists

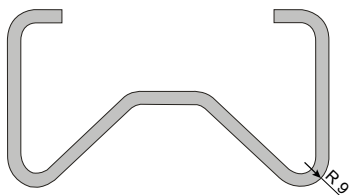

Figure 3.14 Minimum corner radius on safety barrier parts that can be hit by vulnerable road users.

All of today's safety barrier types represent a risk of injury to motorcyclists. The most serious incidents occur when the motorcycle hits sharp edges, protruding sections or non-deformable parts. Therefore, safety barriers with sharp edges or protruding parts that can be struck shall not be used unless they are protected or made softer in some way. Sharp edges are defined here as edges/corners with a radius of less than 9 mm, see Figure 3.14. If plastic, rubber

or similar softer materials are used to protect sharp edges, the radius requirement for these softer parts can be reduced to 3 mm.

The traffic side of bridge parapet posts is protected by a beam, a pipe or a concrete edge and is therefore less exposed to impacts with the post. The requirement for rounded edges therefore does not apply to this type of post, although it would be beneficial to consider rounding when selecting the parapet type.

Safety barriers with a motorcyclist protection device (MCPD) can be erected in locations where there is a significant risk of motorcyclists rolling over and impacting the barrier, and where motorcyclists' speed is great. This can apply to the outer bend of roads along lengths with a high level of motorcycle traffic. On existing roads, MCPDs can be mounted if the curve radii are less than those shown in Table 3.3. On new roads with speed limits ≥ 80 km/h, MCPDs can be mounted for radii $R \leq 500$ m.

Safety barriers with MCPD shall be approved, both MCPD itself and in combination with a previously approved type of safety barrier. The MCPD shall undergo an approval process similar to that which safety barriers are subject to, in addition to being tested for approval together with the barriers. The start and terminal of the MCPD must be given close attention. The MCPD should be mounted 10 cm behind the traffic side of the safety barriers.

Speed level	Curve radius
< 60 km/h	No requirements
60 km/h	R = 90 m
70 km/h	R = 135 m
80 km/h	R = 180 m
≥ 90 km/h	R = 200 m

Table 3.3 Minimum curve radius allowed without the use MCPD at different speed levels.

Table 3.3 does not apply to small radii in connection with junctions.

4 Safety barrier lengths and terminals

4.1 General

A safety barrier, including an adequate terminal, must be sufficiently long that it will be able to protect a vehicle that drives off the road from driving out behind the safety barrier and onwards into the hazard that the barrier is supposed to protect road users against.

Safety barriers must be continuous throughout their entire length, even if they consist of several types.

A safety barrier is normally comprised of five sections: a, b1 and b2, c1 and c2 (see Figure 4.1).

- a) Section a has the same length as the hazard.
- b) Sections b1 and b2 are extensions of the safety barrier, before and after the hazard respectively. These sections will prevent a vehicle that exits the carriageway at a small angle behind the safety barriers, from colliding with the hazard.
- c) Sections c1 and c2 are the barrier terminals, before and after the hazard respectively, and including anchoring, see section 4.3.

Figure 4.1 shows the basis for calculating the length of safety barriers for a given carriageway exit angle (usually 5 degrees). See sections 4.2 and 4.3 for calculating the length of extensions and barrier terminals.

4.2 Calculating safety barrier lengths

Hazards in the roadside area can be divided into 4 main categories (cf. section 2.1):

1. Permanent roadside obstacles
2. Dangerous side slopes
3. Other road users
4. High risk hazards

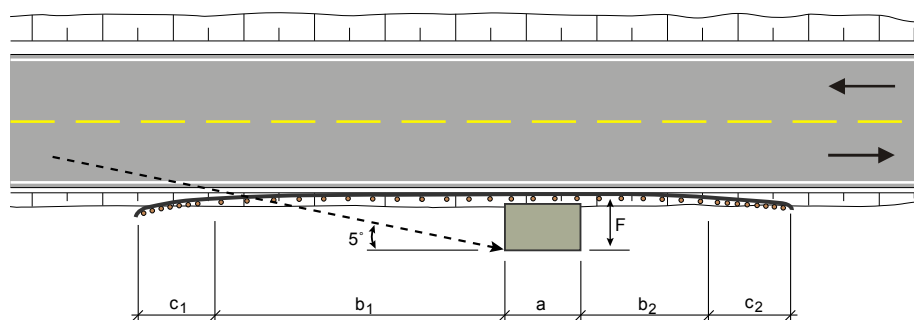

Figure 4.1 Illustration of parameters that are included when calculating the length of the safety barrier extensions

The same method is used to calculate the safety barrier extension for all 4 main categories, but somewhat stricter requirements are made for main categories 3 and 4 because there is a need to protect other road users in the vicinity of the road, or because the consequential damage and injuries will be particularly extensive if a collision were to occur in these locations.

Table 4.1 shows the requirements for safety barrier extensions (b_1) ahead of the location which triggers the barrier requirement. Safety barrier extensions are a function of the speed limit on the road and the hazard involved. Where the speed level varies significantly from the speed limit, the speed level is used (see section 1.9).

Speed level	Normal safety barrier extension b_1 at roadside obstacles and side slopes	Special safety barrier extension b_1 in the case of other road users and high risk hazards
≤ 30	8 m	25 m
50 km/h	30 m	40 m
60 km/h	40 m	55 m
70 km/h	50 m	70 m
80 km/h	60 m	85 m
90 km/h	75 m	100 m
100 km/h	90 m	120 m
≥ 110 km/h*	110 m	150 m

* Applies where the speed level deviates from the speed limit 100 km/h (see section 1.9).

Table 4.1 Extension of safety barriers (b_1) at hazards (cf. section 2.3)

Minimum length of part b_1 that must be parallel to the carriageway:

Speed limit	≤ 80 km/h	8 m
	> 80 km/h	16 m
At tunnel ports		20 m

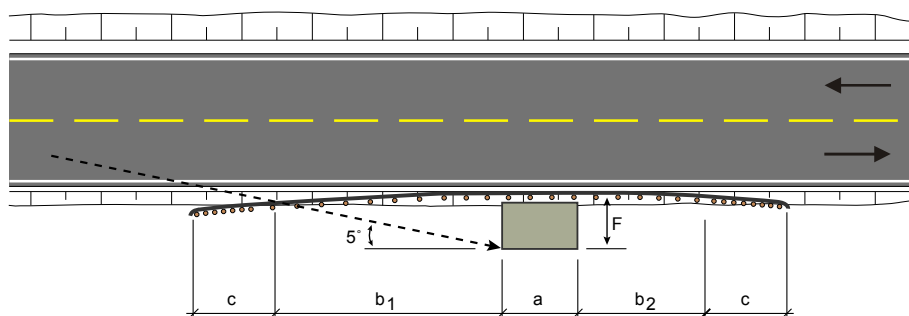

Figure 4.2 Illustration of parameters for simplified calculations

Safety barrier extension b_2 is calculated as follows:

- $b_2 = b_1$ on single-lane carriageways with traffic in both directions, however not less than 8 m
- $b_2 = \frac{1}{2} b_1$ on two-lane carriageways with traffic in both directions

In locations where dangerous roadside obstacles such as sign gantries, bridge piers, tunnel portals and similar are positioned near the back edge of the safety barriers on embankments, level ground without ditches, side slopes gentler than 1:4, or other roadside terrain that will not forcibly guide the vehicle towards the hazardous roadside obstacle, the below equation can be used instead of Table 4.1 to calculate the length of the safety barrier. Other calculations or considerations are permissible in special circumstances. These simplified calculations will provide somewhat shorter safety barrier extensions

$b_1 = 10 \times F$	$b_1 = 0,5 \times 10 \times F$
---------------------	--------------------------------

F is the distance from the front edge of the safety barrier to the back edge of the roadside obstacle, limited to the safety zone's width (S). The equation applies only to F values up to 3 m. See Figure 4.2.

The length of safety barrier terminals (c) is additional. Safety barrier terminations (c1 and c2) serve as an anchoring of the barriers while never representing a risk of damage of injury to road users.

Safety barriers ought not to start in a curve, but before the curve, since there is a greater probability that vehicles will leave the road or impact the terminal in a curve than along a straight stretch of road. This may mean an extension of the safety barriers beyond that given by b_1 (see Table 4.1). Other local conditions may also lead to an extension of the barriers in order to achieve better locating of the terminals.

4.3 Safety barrier terminals

4.3.1 General

Safety barrier terminals must not have parts that extend further into the road than the original barrier alignment.

Safety barrier terminals can be anchored in different ways.

Within the safety zone:

1. The safety barriers are anchored at full height to the roadside terrain, walls, tunnel portals or similar, cf. section 4.3. The anchoring element must not be shaped in such a way that it could cause serious personal injury upon impact (surfaces must be smooth).
2. The safety barriers are anchored using a energy absorbing terminal or a crash cushion, cf. section 4.4.

3. Exceptionally, the safety barrier can be curved outwards, be tapered and anchored over a fixed length within the safety zone (S), cf. 4.3.3.
4. Where none of the above-mentioned solutions are possible, the safety barrier may be curved outwards and be terminated at full height, cf. 4.3.4.

Outside the safety zone:

5. The safety barriers are terminated in a way that provides adequate anchoring and represents no hazard for other road users.

Alternatives 1, 2 and 5 are satisfactory solutions and an endeavour to use them ought to be made. Alternative 3 is permitted downstream for safety barriers on roads with physically divided carriageways and for roads with one-way traffic, as well as roads with a speed limit ≤ 60 km. This alternative gives a significant increase in risk of personal injury and is therefore unacceptable, especially at high speed levels.

Alternative 4 is permissible where it is impossible to terminate the safety barriers in any other way, but a terminal is required because of an exit road or similar. The safety barriers must then curve outwards as far out as possible so that it is impossible to hit the end of the beam from all possible impact angles. The safety barrier manufacturer's recommendations must be followed to achieve adequate anchoring of the terminal.

4.3.2 Outward curving and anchoring into the roadside terrain

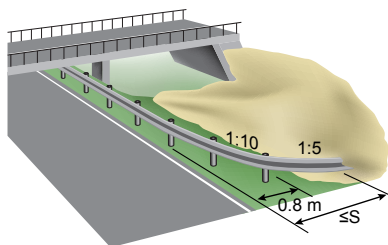

Figure 4.3 Minimum outward curving of the terminal in relation to the original safety barrier alignment.

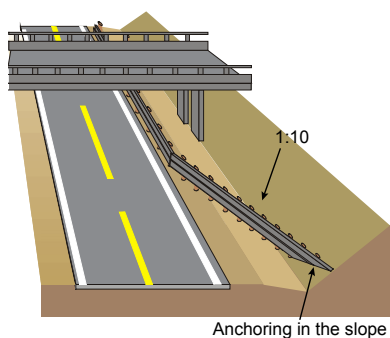

Figure 4.4 Anchoring the safety barriers into the roadside terrain

The start and end sections of the safety barrier should preferably curve outwards 1:10 at its full height and be anchored in the roadside terrain where this is possible (see Figure 4.4). Alternatively, the safety barriers can curve outwards with a maximum flare of 1:10 for the first 0.8 m and thereafter 1:5. See Figure 4.3. On roads with speed limits ≤ 60 km/h, the safety barriers may flare outwards at 1:5 throughout.

Anchoring in earth embankments, rock cuttings, walls or similar is particularly appropriate for closing an opening between the safety barriers and the cutting/wall, in order to prevent vehicles from veering off behind the barrier towards a hazard.

An assessment should always be made as to whether a better solution would be to extend the barriers in order to facilitate anchoring into the roadside terrain.

A condition for being able to lead the safety barrier into a side slope, rock cutting, wall or similar roadside structure is that there is no deep ditch on the verge. Safety barriers must never be installed in a way that allows vehicles to

travel underneath the barrier. To achieve this, it may be necessary to close the ditch locally using culverts and fill. Alternatively, the barrier can be curved downwards into the ditch and if necessary supplied with a further beam underneath the original one. See Manual 267.

The transition between an open and closed ditch shall have a gradient that complies with Table 4.2 or gentler. This is so that an errant vehicle that follows the ditch should not come to a sudden stop in the closed ditch.

Speed limit	Minimum gradient for the transition between closed and open ditches
≤60 m/h	1:6
≥70 km/h	1:8

Table 4.2 Minimum gradient for the transition between open and closed ditches

Anchoring to fixed roadside obstacles such as walls, tunnel portals or similar structures that have a flat end against the direction of traffic is carried out so that the safety barriers are made gradually stiffer towards the roadside obstacle (a transition is made to stiffer safety barriers). Approved transitions shall be used, see section 4.5.

On sections adjacent to bridges and tunnels, there may be a conflict between the safety barrier alignment and cable gates. This is solved by using cast foundations in the same way as for crossing closed ditches, see Manual 267.

4.3.3 Tapered terminals and safety barrier anchoring

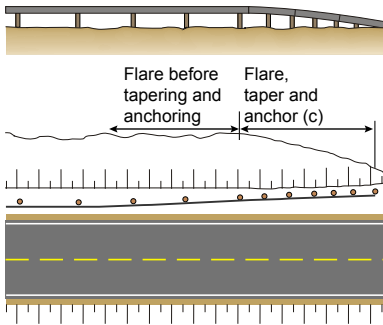
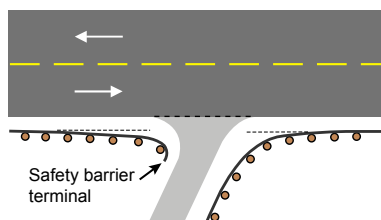

Figure 4.5 Tapered terminals and safety barrier anchoring over 12 metres

On roads with physically divided carriageways and on roads with one-way traffic, a tapered termination shape and anchoring method is acceptable for use downstream of hazards. On roads with a speed limit of ≤ 60 km/h, safety barriers ought to terminate as specified under points 1-2 in 4.3.1, but can also be terminated with tapered barrier terminal within the safety zone. The tapering must continue over at least 12 m. This applies to all types of safety barrier, except for wire safety fences. The manufacturer’s recommendations shall apply for wire safety fences.

It is recommended that the safety barrier should curve outwards by 0.5-1.0 m over the tapered length. It is also recommended that the barrier should curve outwards by 0.5-1.0 m before the tapered length, as illustrated in Fig. 4.5.

4.3.4 Safety barrier terminals at road junctions



a)

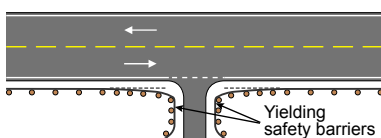

b)

Figure 4.6 a)-b) Examples of safety barrier terminals at crossroads and exit roads

The type of terminal selected for use by a side road/exit road will depend on the roadside terrain, type and speed level. Examples of different terminals are shown in Figure 4.6 a and b. The figures show solutions for standard road safety barriers. For further details, see Manual 267 Standard safety barriers (Standard vegrekkverk).

If there is a possibility at the location of hitting a safety barrier which turns into the junction at an angle ≥ 60 degrees, veering off the road at an angle of 20 degrees, safety barriers with a larger dynamic deflection (D) than 1.0 m shall not be used.

When positioning the safety barrier, it is important to ensure that the visibility at the junction/ exit road is not reduced. It is recommended that the safety barriers curve outwards somewhat before and after the junction to achieve the best possible visibility.

4.4 Energy absorbing terminals

4.4.1 General

Energy absorbing terminals are constructed to avoid injury on impact. These terminals can be divided into two groups. Some are constructed to stop the vehicle upon collision in the road's longitudinal direction, while others yield and allow the vehicle to go through the safety barrier.

Energy absorbing terminals must be of an approved type. This approval is based on ENV 1317-4 or other tests approved by the Directorate of Public Roads.

4.4.2 Selection of energy absorbing terminals

The selection of safety barrier terminals shall take place on the basis of certain performance requirements. These performance requirements comprise:

- Performance class (P), the terminal's level of performance (dependant on the tests passed)
- Trajectory class (Z), the test vehicle's movement after the collision.
- Displacement zones (Dxy), displacement of the terminal as a result of the test impact.
- Impact severity class (A and B), risk of injury to driver and passengers as a result of the test impact.

Performance requirements are discussed in ENV 1317-4.

Decisive factors for the selection of these classes include the containment class of the safety barrier that the terminal is connected to, and speed limit.

Safety barrier's containment class	Terminal's performance class (minimum)	Speed limit
N1	P1	<80
N1	P2	≥80
N2	P2	<80
N2	P3	≥80
H2	P4	All speed limits
H4	P4	All speed limits

Table 4.3 Minimum requirements for the selection of performance classes for safety barrier terminals

On H2 and H4 containment safety barriers, transitions must be used from the stiff barriers to more flexible ones (eks. N2) before an energy absorbing terminal with a performance class P4 can be installed.

Energy absorbing terminals for safety barriers must satisfy the requirements for test vehicle class Z2.

The deformed terminal ought not to extend more than 0.5 m into the carriageway nearest the safety barrier.

4.5 Transitions between different types of safety barriers

4.5.1 General

Transitions must be used between two different types of safety barriers and between safety barriers whose working width differs by than one class.

The transition must be installed according to the manufacturer's specifications.

Overlapping terminals (without mechanical connections) could be an alternative solution for transitions between two different types of safety barrier, for example between two wire safety fences. The overlap shall then be at least 2 posts at full height. Documentation must exist in the form of dynamic calculations carried out by the supplier that the solution described performs as it should.

4.5.2 Transitions between safety barriers of different stiffness classes

Transitions between two types of safety barrier of different stiffness classes shall be sufficiently long to ensure that there will be no sudden changes in the transition's deflection on impact. Changes in the stiffness of the safety barrier ought to increase evenly and gradually from the weak to the stiff system.

Reference is also made to Manual 267 Standard safety barriers (*Standard vegrekkverk*). For other types of safety barriers, the manufacturer/supplier shall specify the nature of the transition. The transition must be approved by the Directorate of Public Roads.

4.5.3 Transitions between safety barriers with different profiles

In some cases it will be necessary to change the type of safety barrier, for example from beam to pipe barriers. Coupling pieces are then needed between the different systems. If the working width of the two safety barriers differs by more than one class, transitions are required in addition to the coupling pieces, see 4.5.2. The manufacturer/supplier must be able to document that the coupling will perform satisfactorily between the relevant safety barriers on impact. The transition must be approved by the Directorate of Public Roads.

4.5.4 Transitions between safety barriers and crash cushions

In special situations it will be appropriate to install crash cushions together with safety barriers so that the barriers form a continuation of the crash cushion, for example at the end of a concrete barrier. The manufacturer/supplier must be able to document that the crash cushion performs satisfactorily with the safety barrier on impact. The manufacturer of the safety barriers must also document that the transition between the crash cushion and the safety barrier performs satisfactorily.

4.6 Positioning of safety barriers in the road's cross-section

4.6.1 General

When positioning and installing safety barriers, and calculating the barrier's length (at both ends), there are a series of conditions that must be evaluated and given consideration.

These are:

- distance from the edge of the carriageway to the safety barriers
- positioning of the safety barriers in relation to any kerbstones or elevated bridge edges
- distance from the safety barriers to the top of the side slope, i.e. anchoring width
- inconvenience to pedestrian and bicycle traffic
- distance from the carriageway edge to the safety barriers and its significance with respect to snow clearance
- visibility and visual alignment

4.6.2 Positioning in the road's cross-section

Safety barriers must not be positioned closer to the roadside hazard than the safety barrier's dynamic deflection (D) or working width (W) allows (see section 3.2). If necessary, the road profile must be extended to achieve adequate displacement space (U) for the barriers.

Safety barriers are usually positioned so that their front edge is in line with the hard-surfaced road shoulder's outer edge to avoid height differences on the road shoulder. For distance values see 2.10.4.

4.6.3 Safety barriers placed on slopes

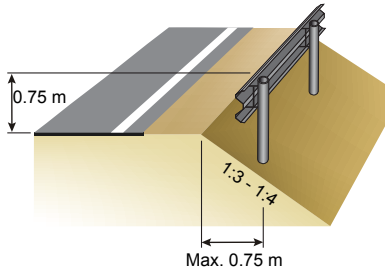

Figure 4.7 Schematic diagram for positioning of safety barriers on side slopes with a falling gradient of 1:3-1:4

Safety barriers can be installed on side slope gradients of 1:5 or gentler. In special cases, it is also permitted to install barriers on side slopes with a falling gradient of 1:3-1:4. Safety barriers may be positioned up to 0.75 m from the top of the slope. Barriers that are erected on side slopes must be tested and approved for the same situation in which they are erected. The installation shall follow the manufacturer’s recommendations. For standard safety barriers reference is made to Manual 267 Standard safety barriers (Standard vegrekkverk).

The terrain in front of the safety barriers and within their working width shall be level, without any protruding sections. Large differences in the level of the terrain will affect the vehicle’s behaviour before and as it hits the barrier. Safety barriers should not be installed on side slopes where large amounts of snow are probable due to the risk of driving over the barriers.

4.6.4 Safety barriers and kerbstones

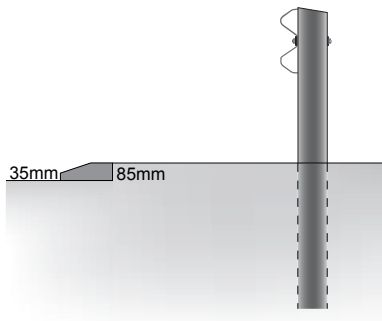

Figure 4.8 Safety barriers positioned a small distance away from the front edge of the kerbstone

When kerbstones are used in connection with safety barriers, they must be of the non-deflecting type (cf. Manual 017 Road and street design (Veg- og gateutforming)). There are no safety barrier installation restrictions in relation to low kerbstones (e.g. the kerbstone has a maximum height of 85 mm from the edge of the asphalt and the slope is 35 mm towards the road) see Figure 4.8.

Kerbstones are not permitted in front of concrete safety barriers unless they are an integrated part of the barrier.

4.6.5 Sideways shifting of safety barriers at roadside obstacles

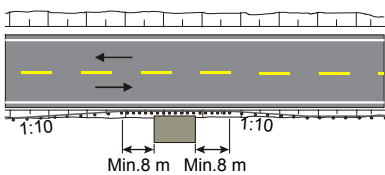

Figure 4.9 Sideways shifting of safety barriers at roadside obstacles

Safety barriers shall usually be positioned at a constant distance from the edge of the carriageway. In some cases, it may be necessary to reduce this distance shifting sideways safety barrier due to roadside obstacles that are close to the road. In such cases, safety barriers with a reduced working width should be used in front of the roadside obstacle. This is achieved by positioning posts closer together and possibly by introducing a back rail.

Where the displacement space (U) between the safety barriers and the roadside obstacle is not sufficient, the barrier's dynamic deflection/working width past the roadside obstacle must be reduced. This can be accomplished by making the safety barriers stiffer by positioning the posts closer together, the use of a back beam, etc.

4.6.6 Snow clearance and the positioning of safety barriers

Where large amounts of snow are expected, the safety barriers ought to be positioned relatively near the carriageway to prevent snowdrifts from forming in front of them. However, there must be adequate space to allow for snow clearance without damage to the barriers. Safety barriers ought therefore to be positioned as specified in 4.6.3.

5 Materials and design

5.1 General

This chapter contains some general requirements for materials and execution of Norwegian standard steel rail safety barriers and concrete barriers that are used on roads and bridges. For more detailed specifications, mounting and detailed drawings for the Norwegian Public Roads Administration's standard safety barriers, reference is made to Manual 267 Standard safety barriers (*Standard vegrekkverk*) and to Manual 268 Bridge parapets (*Brurekkverk*). For detailed information about other safety barriers reference is made to the information provided by the barrier supplier. In addition, see NS EN 1317-5 Road restraint systems - Product requirements, durability and evaluation of conformity.

When purchasing safety barriers, the barrier's durability and total costs over the expected lifespan shall be taken into consideration. Consideration must also be given to necessary warehouse stores of barrier components, so that renovation after damage will be able to be carried out within the period specified in Manual 111 Operation and maintenance (*Standard for drift og vedlikehold av riksveger*).

A calculated lifespan of at least 30 years is required for safety barriers (except parapets) and a longer 50 years lifespan is required for bridge parapets. Those who procure the barriers or parapets shall ensure that documentation for these can be produced by the supplier.

When selecting safety barriers, it is very important that maintenance costs are greatly emphasized. Barriers should be selected that entail low costs for repair after impact, that only to a small degree are damaged by snow ploughs clearing snow, and that have enough strength with respect to snow loading.

Safety barriers must be erected according to the manufacturer's description.

It is assumed that the Norwegian Public Roads Administration always quality assures both the product and the erection itself, especially compression around the posts.

5.2 Materials and execution

Road and bridge safety barriers must be delivered in the material quality they have been tested for. It is not permitted to use materials of a higher or lower quality than that used in the full scale test or simulation. With respect to the Norwegian Public Roads Administration's standard safety barriers, reference is made to the barrier guide, Manual 267 and to the bridge parapet guide, Manual 268.

Contact between different types of materials may be undesirable. This is true, for example, between concrete and aluminium. Special measures are necessary to reduce or eliminate any problems.

5.2.1 Materials and execution

Safety barrier parts in steel shall be treated so that the prescribed lifespan is achieved and environmental requirements met. Barrier parts that are hot finished and/or surface treated in another way must be in accordance with current standards for surface treatment (see Manual 026 General specifications 2, Specification 85.342 class B and otherwise NS EN ISO 1461). With respect to the Norwegian Public Roads Administration standard safety barriers, reference is made to Manual 267. Where bolts are cast in concrete, A4-80 acid proof bolts shall be used pursuant to ISO 3506 (property class equivalent to the previous 8.8). It is recommended that cap nuts be used.

5.2.2 Steel work

Requirements for steel work are found in the Norwegian Public Roads Administration Manual 185 Planning rules for bridges (*Prosjekteringsregler for bruer*) and Manual 026 General Specifications 2, specification 85.

Material quality is to be documented with type 3.2 inspection certificates, see NS EN 10204. Inspection of materials delivered will only be carried out as random sampling in that samples are taken and tested at an accredited test laboratory. This applies to all types of materials that are included in the safety barriers.

5.2.3 Concrete work

For requirements for materials, execution and tolerances for concrete works, reference in general is made to the Norwegian Public Roads Administration Manual 185 Planning Rules for bridges (*Prosjekteringsregler for bruer*), Manual 026 General Specifications 2, specification 87.2 and NS EN13670 Execution of concrete structures and NS EN 206-1 Concrete. Consideration should be given to using textile formwork that drains to achieve the most pore-free surface possible.

5.2.4 Plastic material

Plastic posts, plastic sheathing etc. that is used in safety barrier structures must be a special type that is approved by the Norwegian Public Roads Administration in connection with approval of the barrier system. In repairs and for replacement of parts, only original parts from the supplier that has had the safety barrier approved must be used.

5.2.5 Wood material

Wood material used in safety barriers shall comply with the requirements set by the barrier manufacturer. It must be impregnated and possibly treated so that the prescribed lifespan is achieved and environmental requirements met.

5.2.6 The ground

Ground conditions must be those of a normal road pavement. It is a condition that the tests carried out on the safety barriers are done using the same ground type. Simultaneously, the ground

conditions must not be a sensitive point with respect to the test results since there will be great variations where the safety barriers are placed.

The driven length of the posts must always be as in the full scale test. If it is not possible to obtain adequate anchoring due to a steep slope, poor ground conditions or little space, this must be compensated for with other measures to ensure that the safety barriers are given adequate anchoring.

5.3 Marking safety barrier components

The product shall be marked so that all components can be identified with this information:

- Manufacturer of the component
- Production date (month, year)
- Identification of the material (the steel) that is used, so that the quality of the steel can be traced (steel quality).
- The works that have produced the material (the steel)

Product marking shall be done in such a way that it cannot easily be removed.

The manufacturer/supplier is responsible for marking the product. The design of the marking must be clarified with the Directorate of Public Roads.

6 Crash Cushions

6.1 General

Crash cushions are primarily installed in front of hazardous roadside obstacles that lie within the safety zone and cannot be moved, protected in a satisfactory way with safety barriers or made to yield. Such roadside obstacles include the ends of retaining walls, abutments, bridge piers, the beginning of concrete safety barriers (especially in medians), large sign columns/sign gantries, tunnel portals and blunt walls in tunnels (e.g. in the case of poorly executed emergency lay-bys), concrete buffers at toll stations, blunt walls or concrete barriers at exit ramps etc. Consideration must be given to the fact that a collision with roadside obstacles can often come from both directions.

device crash cushion will decelerate an impacting vehicle in a controlled and satisfactory manner or contribute to redirecting the vehicle past the hazard in the same way as a safety barrier.

Crash cushions are primarily constructed for impacts involving passenger cars. Large vehicles will be slowed down, but not sufficiently fully to secure the safety of these vehicles. It is not technically possible to take care of the concerns of both vehicle groups. Crash cushions are therefore not able to protect posts, sign gantries, bridge piers etc. from being damaged or destroyed by an impact by a heavy vehicle. If a collision with a heavy vehicle would represent a severe hazard for other road users, the hazard must be protected in other ways, for example with safety barriers designed for heavy vehicles (containment level H2, H4).

It is not permissible to place kerbstones in front of, or adjacent to, crash cushions.

6.2 Selection of crash cushions

Crash cushions are selected on the basis of certain performance requirements. These performance requirements comprise:

- the crash cushion's performance level
- the crash cushion's performance in a side impact (redirective or non-redirective crash cushion R/NR)
- the test vehicle's trajectory after impact - vehicle redirection class (Z1-Z4)
- the crash cushion's permanent lateral displacement after the impact test – displacement class (D1-D8)
- risk of injury to drivers and passengers on collision – impact severity class

Performance requirements are briefly discussed below and more thoroughly in NS EN 1317-3.

The correct crash cushion is selected based on the geometric and traffic conditions at the location, the roadside obstacle's width and the crash cushion's deformation characteristics. Redirective crash cushions should be chosen where collisions can occur to the front and side because non-redirective crash cushions do not satisfy the side impact test requirements. It must be assessed whether

a collision with the crash cushion can come from vehicles travelling in the opposite direction and if the device must then be of a type that is tested from the opposite driving direction (165°).

When the right crash cushion is selected, the above performance requirements must be stated. Factors that will be decisive for the selection of these classes include road type, shoulder width, shape of the roadside terrain, AADT, speed level, one-way or two-way traffic etc.

The speed limit (speed level) at the location ought to be equal to or less than that recommended for the crash cushion’s performance class.

6.3 Performance levels for crash cushion

The road’s speed limit (possibly speed level – see section 1.9) is an important factor in the selection of performance level for crash cushions. Selection of the crash cushion based on the speed limit is specified in Table 6.1.

Crash cushion performance level	Speed limit
50	≤ 50 km/h
80/1	60-70 km/h
80	80 km/h
100	90, 100 km/h
110	> 100 km/h

Table 6.1 Selection of performance level for crash cushions

6.4 Redirective and non-redirective crash cushions

Crash cushions are divided into two types according to their ability to contain and decelerate or redirect the vehicle in a side impact.

- Redirective (R)
- Non-redirective (NR)

In a frontal collision, both types will satisfactorily contain and decelerate a vehicle. A redirective crash cushion will redirect the vehicle and thus perform similarly to a safety barrier in a side collision. It must satisfy all the tests in NS EN1317-3. A non-redirective crash cushion that is not designed to redirect a vehicle in a side impact must satisfy only some of the tests in NS EN 1317-3.

6.5 Vehicle redirection classes (Z)

The test vehicle’s movements after impacting a crash cushion are categorised by means of trajectory classes (Z). The selection of a crash cushion according to its trajectory class is based on local conditions.

Crash cushion must satisfy trajectory class Z2.

6.6 Permanent lateral displacement classes (D1-D8)

The crash cushion's permanent lateral displacement after the impact tests is categorised by means of displacement classes (D1-D8). The selected crash cushion's displacement class is determined from the conditions at the location, as given in the table below. The impacted crash cushion should not extend more than 0.5 m into the carriageway nearest the safety barriers

Local conditions	Greatest distance between the crash cushion and carriageway edge(s)	Permanent lateral displacement class (D)
Crash cushion with traffic on both sides	<0,5 m	D1
	<1 m	D2
	<2,5 m	D3
	≥ 2,5 m	D4
Crash cushion with traffic on one side	<0,5 m	D5
	<1 m	D6
	<2,5 m	D7
	≥ 2,5 m	D8

Table 6.2 Selection of displacement classes for crash cushions

6.7 Impact severity

The effects a driver is exposed to when impacting a crash cushion are described by means of the Acceleration Severity Index (ASI) and the Theoretical Head Impact Velocity (THIV). The risk of injury that the driver is exposed to is defined by means of the impact severity class, and crash cushions are divided into two such classes, A and B, by means of these factors (see section 1.8). The requirements with respect to ASI and THIV must be satisfied for both impact severity classes A and B.

Injury class A has a lower ASI value and therefore represents a lower risk of injury. However, both impact severity classes allow little chance of serious personal injury. Both impact severity classes are therefore acceptable.

Appendix 1

Supplementary test requirements for safety barriers

This Appendix addresses the requirements for test vehicle behaviour after impact testing using a safety barrier, and is a supplement to chapter 2.

A.1.1 Containment classes

NS EN 1317-2:2010 provides different containment classes and types of safety barriers. These are shown in Table A.1.1, together with the test criteria that apply for each barrier type. The containment class to be used in different situations is given in 3.2.2.

Containment class	Test criteria				Theoretical energy absorption for comparison	Area of use
	Test	Impact speed	Impact angle	Vehicle weight		
T1	TB 21	80 km/h	8°	1 300 kg	6,2 KNm	Reduced requirements: roadwork areas
T2	TB 22	80 km/h	15°	1 300 kg	21,5 KNm	
T3	TB41 TB 21	70 km/h 80 km/h	8° 8°	10 000 kg 1 300 kg	36,6 KNm 6,2 KNm	
N1	TB 31	80 km/h	20°	1 500 kg	43,3 KNm	Normal Requirements
N2	TB 32 TB 11	110 km/h 100 km/h	20° 20°	1 500 kg 900 kg	81,9 KNm 40,6 KNm	
H1	TB42 TB 11	70 km/h 100 km/h	15° 20°	10 000 kg 900 kg	126,6 KNm 40,6 KNm	Stringent requirements
L1	TB42 TB32 TB11	70 km/h 110 km/h 100 km/h	15° 20° 20°	10 000 kg 1 500 kg 900 kg	126,6 KNm 81,9 KNm 40,6 KNm	
H2	TB51 TB11	70 km/h 100 km/h	20° 20°	13 000 kg 900 kg	287,5 KNm 40,6 KNm	
L2	TB51 TB32 TB11	70 km/h 110 km/h 100 km/h	20° 20° 20°	13 000 kg 1 500 kg 900 kg	287,5 KNm 81,9 KNm 40,6 KNm	
H3	TB 61 TB 11	80 km/h 100 km/h	20° 20°	16 000 kg 900 kg	462,1 KNm 40,6 KNm	
L3	TB61 TB32 TB11	80 km/h 110 km/h 100 km/h	20° 20° 20°	16 000 kg 1 500 kg 900 kg	462,1 KNm 81,9 KNm 40,6 KNm	
H4a	TB 71 TB 11	65 km/h 100 km/h	20° 20°	30 000 kg 900 kg	572,0 KNm 40,6 KNm	Very stringent requirements
H4b	TB 81 TB 11	65 km/h 100 km/h	20° 20°	38 000 kg 900 kg	724,6 KNm 40,6 KNm	
L4a	TB71 TB32 TB11	65 km/h 110 km/h 100 km/h	20° 20° 20°	30 000 kg 1 500 kg 900 kg	572,0 KNm 81,9 KNm 40,6 KNm	
L4b	TB81 TB32 TB11	65 km/h 110 km/h 100 km/h	20° 20° 20°	38 000 kg 1 500 kg 900 kg	724,6 KNm 81,9 KNm 40,6 KNm	

Table A.1.1 Containment classes and test criteria for safety barriers complying with NS EN 1317-2

Two impact tests must be carried out for containment classes T3, N2, H1, H2, H3, H4a and H4b:

- Safety barrier strength test using a large vehicle
- Test to check that the safety barrier also performs with light vehicles

Containment classes L1-L4 correspond to classes H1-H4 expanded to include the TB32 test (i.e. three crash tests must be performed for strength classes L1-L4).

The containment classes are divided hierarchically, so that if a safety barrier satisfies the requirements of one strength class (e.g. H2), the barrier is also approved for all lower strength classes (i.e. H1, N2, N1, T3, T2 and T1). However, for classes N1 and N2, class T3 is not automatically approved. Containment classes L4a and L4b are considered to be equivalent.

A.1.2 The test vehicle's trajectory after an impact

To ensure that the safety barriers will be capable of performing satisfactorily in an impact, there are requirements with respect to the vehicle's trajectory after the impact (cf. NS EN 1317-2).

It is not permissible for the vehicle's post-impact trajectory to cross a line parallel with the pre-impact front of the safety barrier at a distance from the barrier which is equal to A (Table A.1.2) plus the vehicle's width, plus 16% of the vehicle's length. The line starts where the vehicle leaves the barrier after the impact (i.e. from the last point of intersection between the vehicle's wheels (wheel tracks) and the original front of the barrier), and has a length equal to B (see Table A.1.2).

Type of vehicle	A	B
Passenger car	2,2 m	10,0 m
Other vehicles	4,4 m	20,0 m

Table A.1.2 Threshold values for the vehicle's trajectory after crashing into the safety barrier

Nor is it permissible for the vehicle to roll over after the crash. Moderate movement (rolling, yawing and pitching) may be permissible.

A.1.3 Severity of impact

The risk of injury is defined by the impact severity class, and approved safety barriers are divided into two classes, A and B. The deceleration that the driver is exposed to upon impacting with the safety barrier is described by means of the ASI and THIV factors (see section 1.8). The requirements for ASI and THIV in Table A.1.3 must all be satisfied for classification in severity of impact classes A, B or C. Class A has the lowest ASI value and therefore indicates the least extensive personal injury. Class C is only to be used where there are no other alternatives.

Severity of impact class	Threshold values		
A	ASI ≤ 1,0	And	THIV ≤ 33 km/h
B	ASI ≤ 1,4		
C	ASI ≤ 1,9		

Table A.1.3 The maximum deceleration forces required for the severity of impact classes A, B and C.

Appendix 2

Calculation examples – Calculating the safety zone’s width and the need for safety barriers

A.2.1 Calculating safety barrier requirements on embankments/downward sloping terrain

This Appendix shows examples of the following:

- calculating the need for safety barriers in front of embankments
- calculating the need for safety barriers in front of hazardous roadside obstacles

The embankment’s gradient and height are decisive for how an errant vehicle will behave, and whether the bank in itself will represent a hazard. The criteria for calculating safety barrier requirements for embankments are given in section 2.3. The criteria for calculating safety barrier requirements are based on the safety zone width (S) and distance to the road bank (L), and are given in section 2.2 and illustrated in Figure 2.1, Figure 2.2 and Table 2.1. The safety zone’s width is based on the safety distances (A) in Table 2.2 and other criteria are described in section 2.2.

Embankments with gradients of 1:4 or less are so gentle that, to a certain degree, they make it possible to brake or regain control of the vehicle and perhaps to drive it back onto the carriageway. The safety zone width (S) for such banks is equal to the safety distance (A) ($T_2 = 0$), given in Table 2.2.

Banks with gradients steeper than 1:4 are so steep that they force the vehicle down the bank. For such steep banks, the width of the bank down to terrain with a gradient of 1:4 or gentler ($T_2 = \Delta$), must be added to the safety distance (A) to find the safety zone’s width (S).

On embankments with a gradient of 1:3 or steeper, there is a danger of rollover once off the road. The danger of rollover increases with increasing bank gradient and height (h). Such embankment gradients are thus included in the calculation of safety barrier requirements in relation to bank height (h).

Banks with gradients steeper than 1:1.5 are seen in this context to be equivalent to precipices, which require safety barriers even at relatively small differences in height. Driving off the carriageway, the vehicle will often lose contact with the ground with such steep gradients.

If the distance to the top of the bank (L) is less than the safety distance (A) in Table 2.2, the need for safety barriers must be considered. Safety barriers are installed if the sum of the bank heights with gradients of 1:3 or steeper within the safety zone’s width (S) is greater than the largest permitted road bank height (H) given in Tables 2.6 and 2.7.

An inspection should take place to ensure that there are no dangerous roadside obstacles on the bank or at the foot of the bank.

Procedure:

1) The safety zone width is established by using the following formula:

$$S = A + T_1 + T_2 + T_3 + T_4 + T_5$$

Additions for sharp curves T1, other road users T3 and special installations T4 are, in this example, not relevant and thus equal to 0 m. The safety distance (A) is established from the road's traffic load and speed limit in Table 2.2. Additions for embankments, T2, are 0 m unless the bank gradient is 1:4 or gentler. For side slopes with falling gradients steeper than 1:4 that lie within the safety distance (A), addition T2, which is equal to the slope's width (Δ) (measured horizontally) is added to the safety distance (A) to establish the safety zone's width (S) at the location concerned. $S = A + T_2 \Rightarrow S = A + \Delta$

2) The safety zone's width (S) is calculated based on Figure A2.2 below. T2 is the sum of the width of all the side slopes with falling gradients equal to 1:4 or steeper, in so far as the top of the slope lies within the safety zone (A).

3) If any side slope gradients with slope tops within the safety zone have a gradient of 1:3 or steeper, further consideration is given to whether there is a need for safety barriers, see points 4) through 6) below.

4) The distance L from the carriageway edge to the top of the side slope is measured. If $L < S$, further consideration is given to whether there is a need for safety barriers. If $L > S$, there is normally no need for safety barriers.

5) The side slope height (h) is calculated based on Figure A2.2 below. All slopes with a gradient of 1:3 or steeper that lie within the safety zone are included in h.

6) The need for safety barriers is decided based on Tables 2.6 and 2.7. If the sum of the side slope heights (h) that lie within the safety zone exceeds the height limit, H in Tables 2.6 or 2.7, there is a need for safety barriers. Alternatively, the slope must be made gentler.

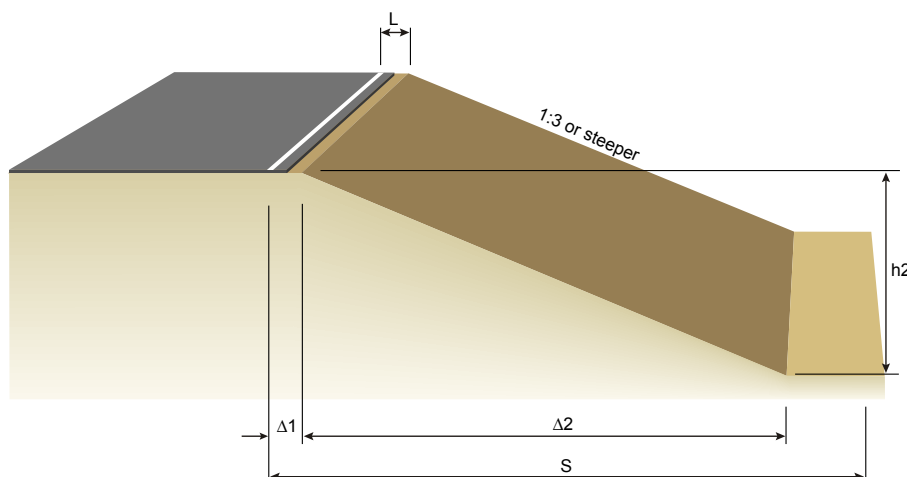

Figure A.2.1 Example of the calculation of the safety zone's width (S) and the need for safety barriers on road banks that are steeper than 1:3.

Example 1 (Figure A 2.1):

Given a road with AADT = 1 000 v/h and a speed limit of 60 km/h.

$L = \Delta 1 = 1 \text{ m}$ $h1 = 0 \text{ m}$ Side slope gradient = 1:3,

$\Delta 2 = 18 \text{ m}$ $h2 = 6 \text{ m}$

- 1) From Table 2.2 we find the safety distance (A) = 3 m.
- 2) The slope gradient of 1:3 is so steep that the slope's width is added to the safety distance (A) to find the safety zone's width (S). The safety zone's width (S) is equal to the safety distance (A) of 3 m plus the width of the side slope gradient, which is 18 m, i.e.
 $S = A + T_2 \Rightarrow S = A + \Delta 2 = 3 \text{ m} + 18 \text{ m} = 21 \text{ m}$.
- 3) The slope gradient is 1:3 or steeper. The need for safety barriers is considered further.
- 4) Distance L to the slope top = 1 m. $L < S$. The need for safety barriers is considered further.
- 5) Slope height $h = h2 = 6 \text{ m}$
- 6) From Table 2.6, we see that the height limit $H = 8 \text{ m}$ for safety barrier requirements at AADT = 1000, speed limit 60 km/h and slope gradient 1:3.
 Since the slope height (h) < height limit (H), there is no need for safety barriers in this instance.

Example 2 (Figure A 2.2):

Given a road with AADT = 6,000 v/h and a speed limit of 80 km/h.

$L = \Delta 1 = 1 \text{ m}$ $h1 = 0 \text{ m}$ $\Delta 4 = 6 \text{ m}$ $h4 = 1 \text{ m}$

$\Delta 2 = 3 \text{ m}$ $h2 = 1 \text{ m}$ $\Delta 5 = 4,5 \text{ m}$ $h5 = 3 \text{ m}$

$\Delta 3 = 4 \text{ m}$ $h3 = 2 \text{ m}$

- 1) Table 2.2 gives us the safety distance (A) = 7 m. We see that $\Delta 2$ and $\Delta 3$ are so steep that they must be added to the safety distance (A). The safety distance (A) will be distributed to $\Delta 1 + \Delta 4$, which together are 8 m. The top of the slope at $\Delta 5$ is outside A, and this part of the slope is therefore not included in the safety zone width (S).

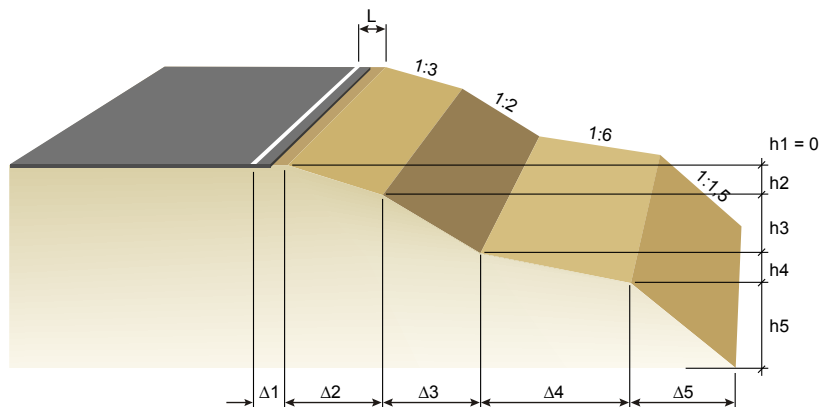

Figure A.2.2 Example of calculating the safety zone's width (S) and the need to install safety barriers on road banks with different gradients

2) The safety zone's width (S) is equal to the safety distance (A) of 7 m plus the width of the slope gradients within the safety distance (A) which is steeper than 1:4, i.e.

$$S = A + T2 \Rightarrow S = A + \Delta 2 + \Delta 3 = 7 \text{ m} + 3 \text{ m} + 4 \text{ m} = 14 \text{ m}$$

3) Side slope gradients $\Delta 2 + \Delta 3$ are 1:3 or steeper. The need for safety barriers is therefore subject to further consideration.

4) The distance to the top of the slope (L) = 1 m. $L < S$. The need for safety barriers is therefore subject to further consideration.

5) Total side slope height (h) that requires safety barriers within the safety zone is equal to the side slope heights $h_2 + h_3 = 1 + 2 \text{ m} = 3 \text{ m}$. All the other slopes have a gentler gradient than 1:3 and therefore do not require safety barriers.

6) Table 2.6 shows that the height limit $H = 3$ for safety barrier requirements at AADT = 4000-12000, speed limit 80 km/h and side slope gradient 1:2. Since the slope height (h) = height limit (H), there is no need for safety barriers in this instance.

A.2.2 Calculating safety barrier requirements in front of hazardous roadside obstacles

Use Figures A.2.3 and A.2.4 below to calculate the need for safety barriers by hazardous roadside obstacles. Safety barriers are erected if the distance to the hazardous roadside obstacle (L) is less than the safety zone's width (S).

The safety zone's width (S) is equal to the safety distance (A) in Table 2.2 if the terrain is flat or has a gradient that is 1:4 or gentler. In special cases with especially hazardous roadside obstacles or where consequential accidents will be especially serious, the safety distance (A) is increased by a factor of 1.5 or 2.0 (see chapter 2 and Table 2.1). Flat terrain or slopes with a gradient of 1:4 or gentler are considered as retardation sections for hazardous roadside obstacles and are therefore included in the safety distance (A).

On slopes with a gradient steeper than 1:4, the driver will not be able to control his vehicle, i.e. the slope will force the vehicle down the slope or to roll over. The width of such bank gradients is therefore added to the safety distance (A) to find the safety zone's width (S) if they lie within the safety distance (A). See the examples in A.2.1.

The distance to the roadside obstacle (L) is the nominal distance to the part of the obstacle that lies nearest the road, measured horizontally from the edge of the carriageway.

Procedure:

1) First, the road's safety zone must be established starting with the road's safety distance (A). The safety distance (A) is found from the road's traffic load and speed limit in Table 2.2. The safety zone's width (S) is equal to the safety distance (A) of 3 m plus the width of the side slope gradient which is 18 m, i.e. $S = A$. For side slopes with gradients steeper than 1:4 that lie within

the safety distance (A), the bank width (measured horizontally) is added to the safety distance (A) to find the safety zone's width (S), i.e. $S = A + T_2$.

- 2) The distance to the roadside obstacle (L) is measured from the edge of the carriageway.
- 3) If $L > S$, there is normally no need for safety barriers. If $L < S$, safety barriers are required.

Example 3

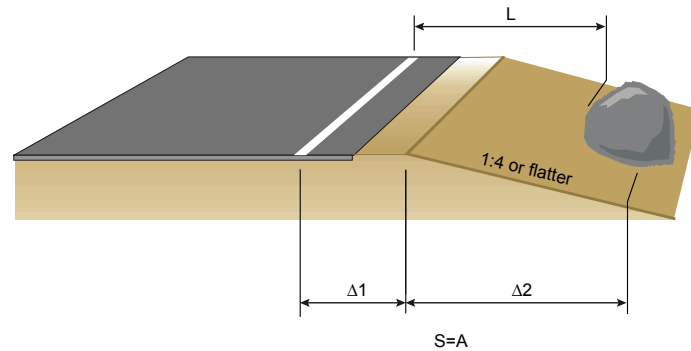

Figure A.2.1 Example of calculating the safety zone width (S) and the need for safety barriers at hazardous roadside obstacles in flat roadside terrain or on road banks with a gradient of 1:4 or gentler.

Safety zone width (S) = safety distance (A) where the road bank is 1:4 or gentler, i.e. $T_2 = 0$. Safety barriers are erected if the distance to the hazard (L) is less than the safety zone width (S). The figure shows that $L < S$, and that therefore, safety barriers are required.

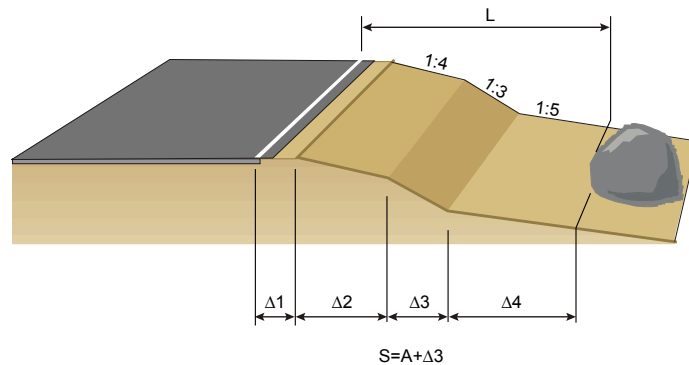

Figure A.2.2 Example of calculating the safety zone width (S) and need for safety barriers at hazardous roadside obstacles on road banks with a gradient of 1:4 or steeper

Example 4 (Figure A 2.4):

Given a road with AADT = 11,000 v/h and a speed limit of 70 km/h.

$\Delta 1 = 1 \text{ m}$ $\Delta 2 = 3 \text{ m}$ $\Delta 3 = 2 \text{ m}$ $\Delta 4 = 4 \text{ m}$ $L = 11 \text{ m}$

- 1) From Table 2.2 we find the safety distance (A) = 7 m

2) The safety zone's width (S) is equal to the safety distance (A) of 7 m plus the width of the side slope's gradients within the safety distance (A) that are steeper than 1:4, i.e. $\Delta 3 = 2$ m. Together, the safety zone's width: $S = A + T2 \Rightarrow S = A + \Delta 3 = 7 + 2 = 9$ m.

Slope gradients $\Delta 1 + \Delta 2 + \Delta 4$ equal 1:4 or gentler, and are therefore not added to the safety distance (A).

3) The distance to the roadside obstacle (L) = 11 m

4) $L < S$. There is therefore no need for safety barriers.

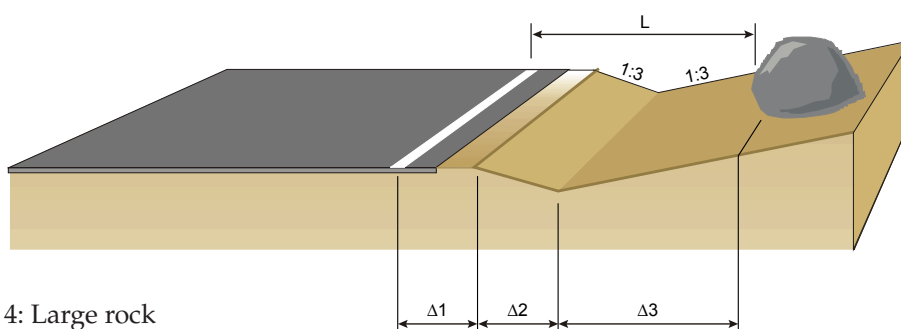

Example 4: Large rock

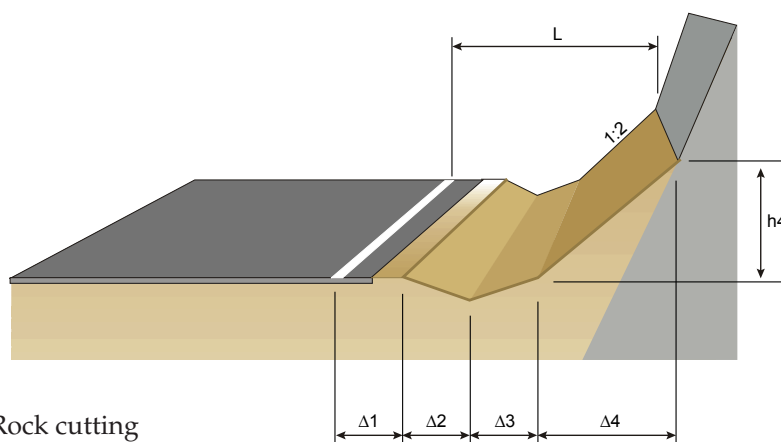

Example 5: Rock cutting

Figure A.2.5.3 Examples of the safety zone width (S) and the need for safety barriers at hazardous roadside obstacles in road cuttings

Example 4 (Figure A 2.5):

Given a road with AADT = 6000 v/h and a speed limit of 60 km/h.

$L = 5$ m $\Delta 1 = 1$ m $\Delta 2 = 1$ m $\Delta 3 = 3$ m

1) From Table 2.2 we find the safety distance (A) = 5 m.

2) The safety zone width (S) is equal to the safety distance (A) plus the ditch slope's width $\Delta 2$ with a gradient of 1:3 down to the ditch bottom, $S = A + T2$.

The slope up from the bottom of the ditch has a gradient of 1:3 and is therefore included in the safety distance (A), since slopes with a gradient of 1:2 or gentler are included in the safety distance and do not give an addition to A. All together, the safety zone width $S = A + T_2 \Rightarrow S = A + \Delta_2 = 5 + 1 = 6$ m.

- 3) The distance to the roadside obstacle (L) = 5 m.
- 4) $L < S$. Safety barriers are therefore required.

Example 5 (Figure A 2.5):

Given a road with AADT = 15 000 v/h and a speed limit of 90 km/h.

$L = 5$ m $\Delta_1 = 1$ m $\Delta_2 = 1$ m $\Delta_3 = 1$ m $\Delta_4 = 2$ m, $h_4 = 1$ m.

- 1) From Table 2.2 we find the safety distance (A) = 10 m.
- 2) The slope up to the rock cutting has a gradient of 1:2 (with a falling gradient of 1:3 from the verge down to the bottom of the ditch). According to 2.2.4, the safety zone width (S) in such cases is measured out to a point where the side slope height is 2.0 m above the carriageway if the gradient is 1:2 and the point lies within the safety distance (A). In this case, the rock cutting lies 1 m above the carriageway level and is thus inside this height limit. The safety zone width (S) is then measured to the rock cutting and becomes $S = A + T_2 \Rightarrow S = A + \Delta_2 = 10$ m + 1m = 11 m from the carriageway edge.
- 3) The distance to the rock cutting (L) = 5 m.
- 4) $L < S$. Safety barriers are therefore required.



Statens vegvesen

Manuals can be ordered at:

Statens vegvesen Vegdirektoratet
Publikasjonsekspedisjonen
Bok 8142 dep.
0033 Oslo, Norway

Tlf. 22 07 35 00
Faks. 22 07 37 68
publvd@vegvesen.no

ISBN 978-82-7207-652-7