



Energieffektive tunneler - ENERTUN - D3.1

Etatsprogrammet Varige konstruksjoner 2012-2015

STATENS VEGVESENS RAPPORTER

Nr. 556



Tittel

Energieffektive tunneler -
ENERTUN - D3.1

Undertittel

Measures to increase the energy efficiency in
road tunnels

Forfatter

Luis Miguel Gonzalo, Geocontrol

Avdeling

Trafikksikkerhet, miljø- og
teknologiavdelingen

Seksjon

Tunnel og betong

Prosjektnummer

603242

Rapportnummer

Nr. 556

Prosjektleder

Synnøve A. Myren / Harald Buvik

Godkjent av

Harald Buvik

Emneord

Varige konstruksjoner, fremtidens tunneler,
ENERTUN, energieffektive tunneler

Sammendrag

Denne rapporten er den fjerde av totalt seks rapporter fra et to-årigt FoU-samarbeid. Varige konstruksjoner har med det spanske engineering-selskapet Geocontrol. Samarbeidet er rettet mot utvikling av energieffektive tunneler gjennom prosjektet ENERTUN som Geocontrol leder. ENERTUN gjennomføres i regi av EEA GRANTS, en samarbeidsorganisasjon der EØS-landene Norge, Island og Lichtenstein gir midler og tilskudd (via Innovasjon Norge) til 16 EU-land i Sentral- og Sør-Europa.

Rapporten gir en oversikt over mulige tiltak for å redusere energiforbruket gjennom optimalisering av energiforsyning og drift, og mulig bruk av solkraft, vindkraft, hydroelektrisk energi.

Title

Energy efficiency in tunnels- ENERTUN -
D3.1

Subtitle

Measures to increase the energy efficiency in
road tunnels

Author

Luis Miguel Gonzalo, Geocontrol

Department

Traffic Safety, Environment and Technology
Department

Section

Tunnel and concrete

Project number

603242

Report number

No. 556

Project manager

Synnøve A. Myren / Harald Buvik

Approved by

Harald Buvik

Key words

Durable structures, future tunnels, ENERTUN,
energy efficient tunnels

Summary

This report is the fourth of a total of six reports from a two-year R&D collaboration. Durable structures have with the Spanish engineering company Geocontrol. The partnership is aimed at developing energy efficient tunnels through the project ENERTUN as Geocontrol leads. ENERTUN is pursued by the EEA GRANTS, a cooperative organization where the EEA countries Norway, Iceland and Lichtenstein provides funds and grants (via Innovation Norway) for 16 EU countries in Central and Southern Europe.

The report provides an overview of possible measures to reduce energy consumption through optimization of energy supply and operations, and the potential use of solar power, wind power, hydroelectric energy.

Forord

Denne rapporten inngår i en serie rapporter fra **etatsprogrammet Varige konstruksjoner**. Programmet hører til under Trafikksikkerhet-, miljø- og teknologiavdelingen i Statens vegvesen, Vegdirektoratet, og foregår i perioden 2012-2015. Hensikten med programmet er å legge til rette for at riktige materialer og produkter brukes på riktig måte i Statens vegvesen sine konstruksjoner, med hovedvekt på bruer og tunneler.

Formålet med programmet er å bidra til mer forutsigbarhet i drift- og vedlikeholdsfasen for konstruksjonene. Dette vil igjen føre til lavere kostnader. Programmet vil også bidra til å øke bevisstheten og kunnskapen om materialer og løsninger, både i Statens vegvesen og i bransjen for øvrig.

For å realisere dette formålet skal programmet bidra til at aktuelle håndbøker i Statens vegvesen oppdateres med tanke på riktig bruk av materialer, sørge for økt kunnskap om miljøpåkjenninger og nedbrytningsmekanismer for bruer og tunneler, og gi konkrete forslag til valg av materialer og løsninger for bruer og tunneler.

Varige konstruksjoner består, i tillegg til et overordnet implementeringsprosjekt, av fire prosjekter:

- Prosjekt 1: Tilstandsutvikling bruer
- Prosjekt 2: Tilstandsutvikling tunneler
- Prosjekt 3: Fremtidens bruer
- Prosjekt 4: Fremtidens tunneler

Varige konstruksjoner ledes av Synnøve A. Myren. Mer informasjon om prosjektet finnes på vegvesen.no/varigekonstruksjoner

Denne rapporten tilhører **Prosjekt 4: Fremtidens tunneler** som ledes av Harald Buvik. Prosjektet skal bidra til at fremtidige tunneler bygges med materialer, utførelse og kontroll bedre tilpasset det miljøet konstruksjonene er utsatt for. Prosjektet skal bygge videre på arbeidet i Moderne Vegtunneler, samt innspill fra Prosjekt 2: Tilstandsutvikling tunneler, med hovedfokus på tunnelkonstruksjonen i et levetidsperspektiv. Prosjektet skal resultere i at installasjoner i fremtidige tunneler oppnår tiltenkt levetid med reduserte og mer forutsigbare drift- og vedlikeholdskostnader.

Rapporten er utarbeidet av *Luis Miguel Gonzalo, Geocontrol*.

**EFICIENCIA ENERGÉTICA EN TÚNELES
ENERTUN
ENERGY EFFICIENCY IN TUNNELS**



Statens vegvesen



Cristóbal Bordiú 19-21, 5º, 28003 Madrid - T. 91 553 1763 - F. 91 554 9396
geocontrol@geocontrol.es - www.geocontrol.es

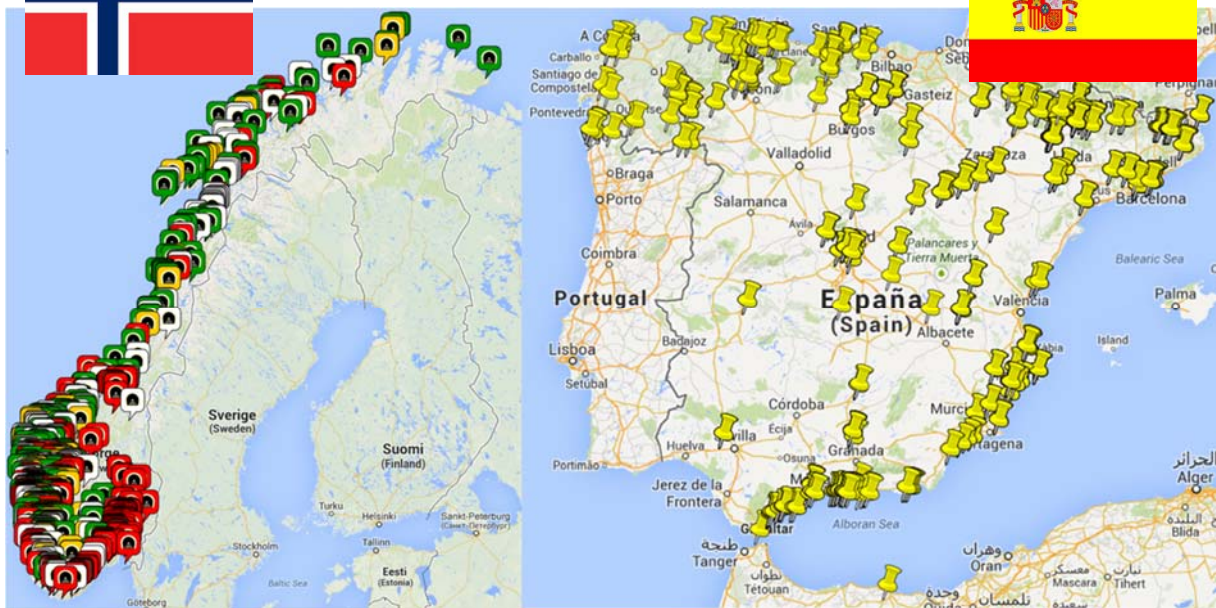

DELIVERABLE 3.1.- MEASURES TO INCREASE THE ENERGY EFFICIENCY IN ROAD TUNNELS

	Written by	Revised by	Approved by
Name:	LMG	RST	RST / HB
File:	1411_deliverable_d3.1_v00_r03		



ENERTUN

DELIVERABLE 3.1.- MEASURES TO INCREASE THE ENERGY EFFICIENCY IN ROAD TUNNELS

INDEX

1. INTRODUCTION	2
2. VENTILATION SYSTEM	4
2.1. CHARACTERISTICS OF THE FOLGOSO TUNNEL	5
2.2. CASES FOR THE ACTIVATION OF THE TUNNEL'S VENTILATION SYSTEM	6
2.3. FOLGOSO TUNNEL'S OPTIMISED ALGORITHM FOR SANITARY VENTILATION	7
2.3.1. CONCENTRATION CONTROL OF CO, NO AND OPACITY	8
2.3.2. AIR VELOCITY CONTROL	11
2.3.3. DEGRADED MODE OPERATION	11
2.4. COMPARISON WITH A NON-OPTIMISED ALGORITHM FOR SANITARY VENTILATION	12
2.5. EFFICIENCY MEASURES	13
3. LIGHTING SYSTEM	14
3.1. MIRAVETE TUNNEL CHARACTERISTICS	15
3.2. REDESIGN OF THE LIGHTING INSTALLATION	16
3.2.1. LIGHTING VALUES	16
3.2.2. LUMINARY'S TECHNOLOGY	18
3.3. CALCULATION OF THE HOURS OF OPERATION PER MONTH OF EVERY LIGHTING LEVEL	19
3.4. OTHER POSSIBLE EQUIPMENT TO OPTIMISE THE LIGHTING OPERATION	22
3.5. EFFICIENCY MEASURES	24
4. SELF – GENERATION OF ENERGY	25
4.1. WIND ENERGY	25
4.1.1. BIELSA TUNNEL CHARACTERISTICS	25
4.1.2. MEASURING CAMPAIGN	30
4.1.3. EFFICIENCY MEASURES	32
4.2. SUN'S ENERGY	34
4.2.1. MIRAVETE TUNNEL STUDY	36
4.2.2. EFFICIENCY MEASURES	38
4.3. HYDROELECTRIC ENERGY	39
4.3.1. EFFICIENCY MEASURES	41
5. CONCLUSIONS	42



ENERTUN

DELIVERABLE 3.1.- MEASURES TO INCREASE THE ENERGY EFFICIENCY IN ROAD TUNNELS

1. INTRODUCTION

In previous stages of the Enertun project, the preponderance of the different sources of energy consumption have been studied and analysed.

Once the contribution of the main sources has been established, the next step forward consists on analysing which measures might be set in order to reduce the energy expenditure. The aim of the present report is to make a further analysis and verify the positive effect, as far as energy consumption is referred, when some specific measures or improvements take place. For this purpose, the study has been conducted through real cases of road tunnels.

There are two main branches in this report that have been studied:

- ◆ Reduction of the energy consumption through optimisation of the system's operation.
- ◆ Increase of the generated power through wind energy, power from the sun and hydro electrical energy.

The development of the Work Package 3 (WP3) is closely related to the Work Package 2 (WP2), since:

- ◆ During the development of the WP2, the main energy sources of every tunnel have been analysed. This way, it has been possible to determine the most potential ways of increasing the energy efficiency in a road tunnel.
- ◆ During the development of the WP3, the first data and mathematical model from the WP2 have been employed, so as to prioritise the study on the systems whose consumption is likely to be more relevant.

As it has been stated in the documents of the Work Package 2, the systems where the energy consumption is more relevant are the lighting system and the ventilation system.



In this section, it will be explained the possible measures to set in both systems to reduce energy consumption and also, it will be outlined the measures to provide self – generation of energy.

The Work Package 3 is divided into 3 different tasks:

- ◆ T3.1, which is developed in the section 2 of the present document, where all the measures related to the ventilation system are analysed.
- ◆ T3.2, which is discussed in the section 3 of the present document, where all the measures related to the lighting system are analysed.
- ◆ T3.3, which studies the different possibilities for self- energy generation, is analysed in the section 4 of the present document.



2. VENTILATION SYSTEM

In road tunnels, the ventilation system is in charge of maintaining the pollution levels within the admissible margins already established. The normal procedure consists of making this system operate whenever it is detected a pollution level that exceeds the limit, until the exploitation levels are re-established.

The study from the WP2 has revealed that, in bidirectional tunnels, the ventilation system constitutes one of the main sources of energy expenditure. For unidirectional tunnels, the WP2 has also revealed that in the case of unidirectional tunnels, the sanitary ventilation only gets activated when there is traffic congestion.

In general, the procedure for sanitary ventilation is the following one:

- ◆ For unidirectional tunnels, the sanitary ventilation gets activated in the traffic's direction.
- ◆ For bidirectional tunnels, the sanitary ventilation gets activated in the direction where the piston effect of the vehicles is higher.

The aim of this report is to develop a further analysis, through the study of a real case, of the efficiency measures that can be taken in practice in a road tunnel to reduce the ventilation consumption. The study has been carried out only involving the ventilation consumption due to sanitary reasons, as the fire scenario is exceptional.

Initially, it was foreseen studying energy efficiency measures focused on improving the piston effect, such as reducing the friction with the concrete walls. However, it has been verified thanks to the mathematical model developed in the WP2 that the improving margin concerning the friction reduction is rather low and its relevance can be neglected; even more: the modification of the tunnel's walls friction has a high cost of implementation as a result.

Nearly all the tunnels that have been included in the present work with ventilation system have a unidirectional one, based on jet fans. Therefore, no data are available to assess the performance of other kind of ventilation systems and they have consequently been excluded from this study.

In the last years, the energy efficiencies obtained in the design of jet fans remain practically unchanged and the CFD simulations so as to improve their efficiency have a further scope than the one of the present study.

During the WP2 it has also been verified that the energy consumption of the Folgoso Tunnel presented some deviations from the mathematical model, due to the use of the ventilation system in case of fog entering the tunnel.

This is a problem that has been affecting some tunnels in the A-8 highway in Spain, so it has been created a working group to study the different solutions other than activating the ventilation system.

At this moment, all the solutions are based on the construction of barriers or extending the end of the tunnels with prefabricated panels. These solutions don't have energy consumptions as a result and, consequently, there is no sense in talking about energy efficiency.

Once other possibilities for the optimisation of the ventilation system have been ruled out, the optimisation of the ventilation algorithm is the only one considered as feasible. More specifically, the real case of the Folgoso Tunnel will be analysed.

2.1. CHARACTERISTICS OF THE FOLGOSO TUNNEL

In order to carry out a study of a real case, the Folgoso Spanish Tunnel has been selected.

The **Figure 2.1.I** shows the main characteristics of this road tunnel:

FOLGOSO'S TUNNEL		
Situation		
Road	A-52	
PK entrance portal	278+540	
PK exit portal	281+085	
Number of tubes	2	
Type of traffic	Unidirectional	
Tubes		
Name	Folgoso 1	Folgoso 2
Identification code	52-PO-30200	52-PO-30100
Direction	Vigo	Orense
Longitudinal section		
Length	2536	2543
Maximum slope	-2%	2%
Cross-sectional section		
Maximum height	8,00 m	8,00 m
Authorised gauge	4,50 m	4,50 m
Tunnel's width	10,60 m	10,60 m
Number of lanes	2	2

Table 2.1.I.- Characteristics of the Folgoso Tunnel.

In this section it will be explained the algorithm that has been integrated in the Folgoso Tunnel for sanitary ventilation, which will let to extract ideas for general efficiency measures for this system.

2.2. CASES FOR THE ACTIVATION OF THE TUNNEL'S VENTILATION SYSTEM

The situations that make the ventilation system operate are:

- ◆ When the concentration of pollutant gases exceeds the admissible margins already stated. The variables commonly considered to supervise in the tunnels are CO and NO_x concentration and the opacity.
- ◆ When there's the phenomenon of fog inside the tunnel.

It has been calculated, according to the publication "*Road Tunnels: Vehicle Emissions and Air Demand for Ventilation*" of the PIARC, the air flow required for sanitary ventilation for the year 2020 in each tube. This is shown in the **Figure 2.2.I**, where there is a comparison between the airflow required for sanitary reasons and the airflow generated by the piston effect of the vehicles:

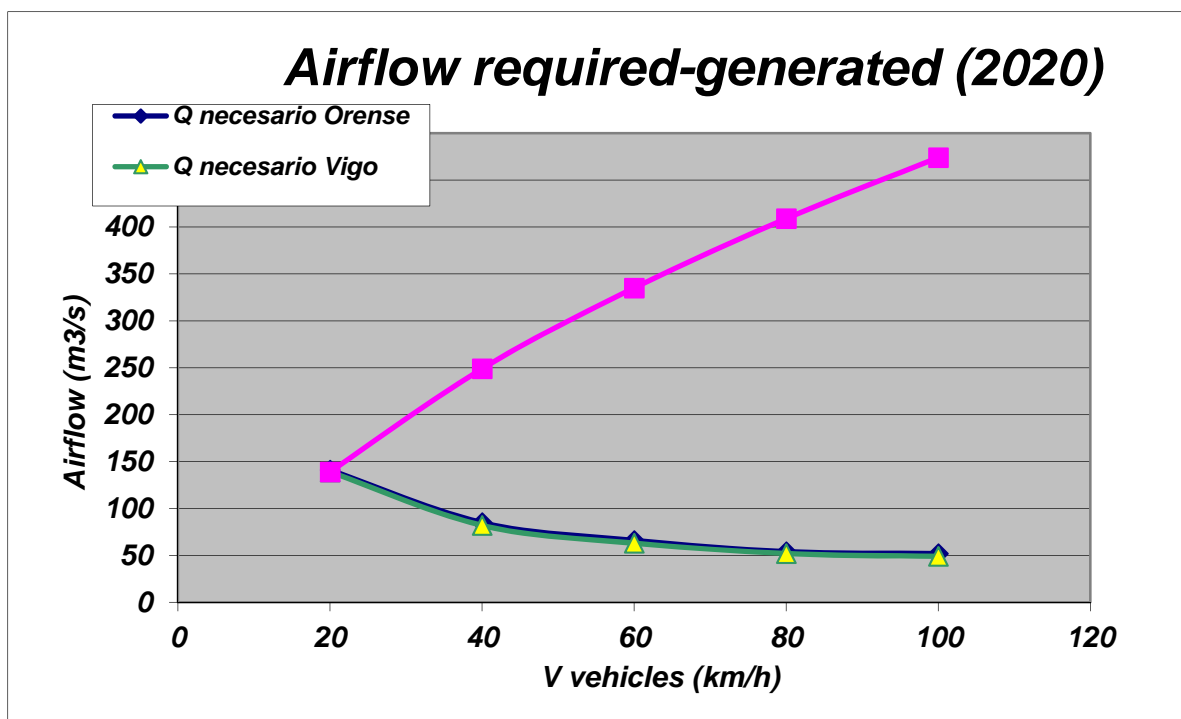

Figure 2.2.I.- Comparison between airflow required and generated in each tube for the Folgoso Tunnel

From the **Figure 2.2.I**, it can be observed that this algorithm would be activated just in case of traffic congestion, which means that the vehicles' mass velocity is lower than 20 km/h. If the mass vehicles' velocity is higher than 20 km/h, the piston effect of the vehicles is enough to assure the pollutants dilution.

The mathematical model delivered in the Work Package 2 has allowed carrying out a sensibility analysis for the Folgoso tunnel, to know the effect of some factors on the sanitary ventilation.

The **Table 2.2.II** shows the effect on gases concentration of the tunnel's length, hourly traffic rate (HTR), slope and Heavy Goods Vehicles rate (HGV rate):

Gases Concentration	Increase in factor			
	Length	HTR	Slope	HGV rate
CO	↗	↗	↗	↘
NOx	↗	↗	↗	↗
Opacity	↗	↗	↗	↗

Table 2.2.II.- Effect of changes in main factors on the pollution level.

In general, the increase effect of the main factors turns out in an increase of the pollution level. However, as CO is referred, it has to be underlined that the tendency is reverse: the higher the Heavy Goods Vehicles rate is, the lower the CO concentration levels are. The reason for this is that probably most of the Heavy Goods Vehicles have diesel engines, with lower emissions of CO gas.

It has to be underlined the particular case of the fog, which is a meteorological phenomenon that takes place in some places. It may be stated that the tunnel's altitude is closely related to the appearance of this phenomenon.

When fog appears in the tunnel, it is necessary to get the sanitary ventilation activated, as this situation may be a risk for the tunnel's users, due to the reduction of visibility. The presence of the fog is traduced in an increase of the opacity level.

2.3. FOLGOSO TUNNEL'S OPTIMISED ALGORITHM FOR SANITARY VENTILATION

In normal situation, the aim of the sanitary ventilation is the dilution of pollutant gases inside the tunnel. There are some environmental detectors placed throughout the tunnel, for collecting data of the concentration of CO, NOx and the opacity.

Since this tunnel has been designed with unidirectional ventilation, the pollutant gases will be rejected by the exit portal, as the ventilation operates in the direction of the traffic. This way, the rule is that the direction of ventilation is the same as the direction of the traffic in these tunnels.

Depending on the data collected of the concentration levels of CO, NOx and opacity, the number of jet fans switched on varies. The control system selects the fans to be turned on depending on their availability, accumulated working hours and number of starts of every jet fan.

This is a dynamic solution, in which the number of active jet fans is not always the same, but it depends on the environmental conditions of the tunnel just before making the calculation of the new ventilation algorithm.



All the temporal starts of the jet fans are configurable, with the only exception that it must be respected the multiplicity of the periods involved in the algorithm.

The ventilation algorithm presents the following stages:

2.3.1. Concentration control of CO, NO and opacity

In every cycle, the control system verifies the level of concentration of all the detectors, in such a way that the levels of the CO, NO and opacity are the ones that establish the required ventilation power in every tunnel.

The concentration levels of pollutant gases are obtained through 3 combined CO-opacity detectors and 3 combined NO-opacity detectors in every tunnel. The control system will verify the pollution level according to a pre-established frequency which may be varied and configured. This frequency is 20s by default, but it shouldn't be higher that one minute.

With the aim of solving the fluctuation's problem in the measures, a low-pass filter is employed, with configurable filter defining parameters. In the following picture it is shown an example of this filter:

Time (s)	Data CO (ppm)	Media CO (ppm)
0	37	
20	41	
40	53	
60	43	
80	44	
100	38	
120	41	
140	35	
160	32	
180	38	40,2
200	39	40,4
220	44	40,7
240	41	39,5
260	50	40,2
280	47	40,5
300	52	41,9
320	45	42,3
340	44	43,2
360	53	45,3
380	50	46,5
400	58	48,4
420	50	49

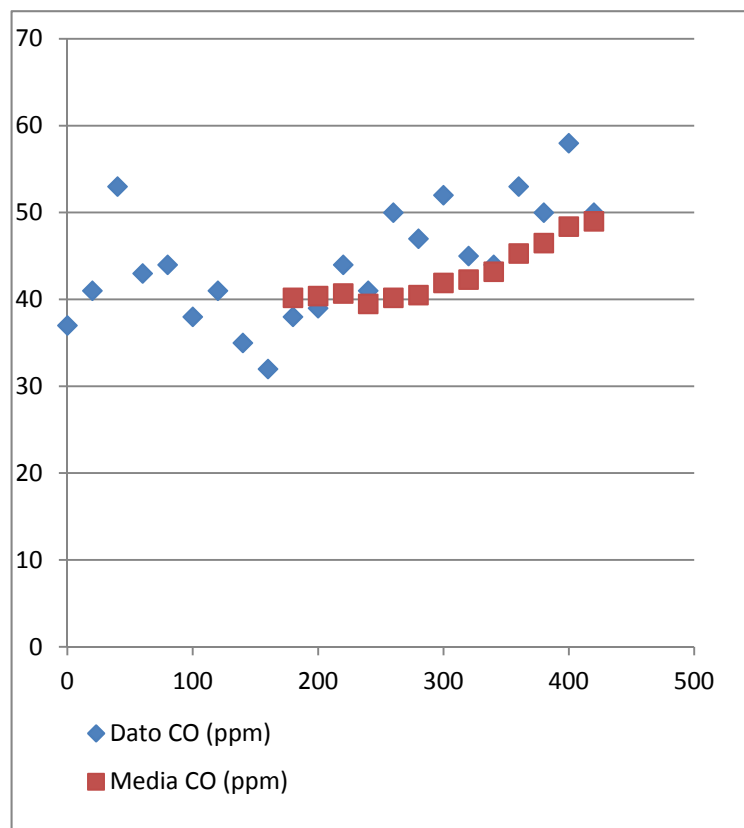



Four thresholds have been foreseen for every variable to supervise. Their default values are the ones shown in the following table but they are configurable through the interface of the operator.

	CO (ppm)	Opacity (m ⁻¹)	NO (ppm)
Low threshold	30	3·10 ⁻³	0,5
Medium threshold	50	5·10 ⁻³	0,6
High threshold	100	7·10 ⁻³	0,7
Alert threshold	150	9·10 ⁻³	0,8

Table 2.3.1.I.- Pollution levels integrated in the control system

The steps to follow are associated to some levels of pollution determined by the 5 intervals defined by the previous 4 thresholds. These intervals are shown in the following table:

	Pollution concentration		Action
	Lower limit	Upper limit	
Level 1	0	Low threshold	-1 vent/cycle
Level 2	Low threshold	Medium threshold	0 vent/cycle
Level 3	Medium threshold	High threshold	+1 vent/cycle
Level 4	High threshold	Alert threshold	+2 vent/cycle
Level 5	Alert threshold	∞	All the jet fans

Table 2.3.1.II.- Pollution levels integrated in the control system.

The steps explained in the above lines don't define a specific number of jet fans to switch on but the increment or decrement of the jet fans per cycle. The previous four thresholds establish five levels and, therefore, five different actions to undertake.

The following figure shows, in a schematic way, the algorithm for sanitary ventilation:

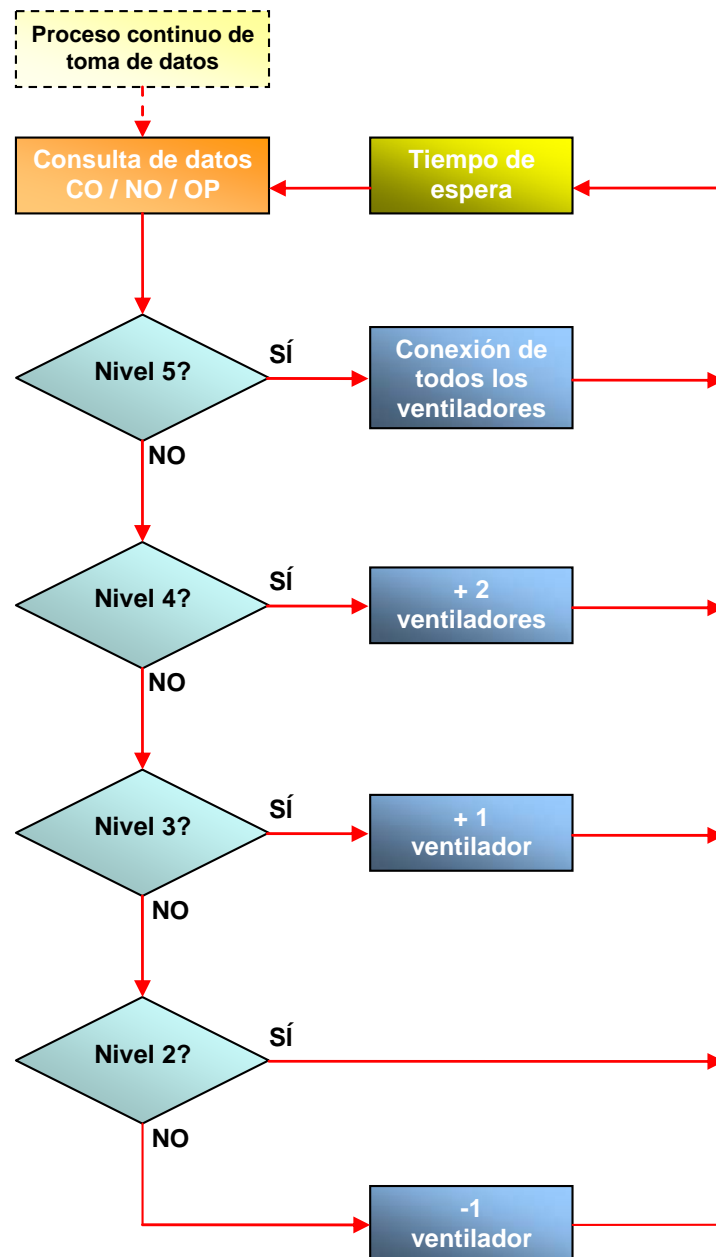

Figure 2.3.1.III.- Algorithm for sanitary ventilation in the Folgoso tunnel.

The choice of the jets that will be switched is made depending on the following parameters, according to their priority:

- ◆ Choose the available ventilators with no alarms (temperature, vibration, etc).
- ◆ Avoid ventilators that have been operating in the last five minutes.
- ◆ Choose the ventilator with fewer accumulated hours of operation.



This way, the jet fans degradation is minimised and, therefore, the uniformity of their operation is optimised.

Furthermore, a too rapid change of the direction of operation in a jet fan will not be allowed; it is the software which will let the jet stop operating, through a configured time.

Besides, the electrical switchboards associated with the ventilation system provide circuits for manoeuvre to try to avoid this rapid inversion.

2.3.2. Air velocity control

When the pollution levels don't exceed the admissible margins established, the priority of the algorithm is to make a renovation per hour, which is achieved maintaining air velocities over 0,15m/s.

Every four cycles the average value of the data collected by the anemometers is checked and, depending on this, a jet is switched if the average air velocity is lower than the one required for the air renovation.

2.3.3. Degraded mode operation

When one of the environmental detectors (CO, NO, opacity, anemometer) presents a failure in its operation, it may lead to an erratic operation in the ventilation system. In order to avoid this situation, there is the possibility of disabling manually the detector's operation and thus, its contribution to the ventilation algorithms.

In case of communication failure of one of the control elements (automated logic controller or other), the order of ventilation operation will be maintained for those jets that were operating until the recovery of the communication.

If an automated logic controller loses its communications with the Control Centre, it starts operating in degraded mode. In this case, the algorithm is simplified, since only the data collected for CO and opacity are supervised, not having control anymore over the tendencies or the velocity control.

In case of momentarily loss of power voltage supply or way of power supply mode (commutation between electric network and electrical generator or vice versa) in a transformation centre, another algorithm is in charge of the situation. The algorithm for the electrical control is the one that distributes the power charges in the tunnel so that they are in accordance to the real power supply capacity.

2.4. COMPARISON WITH A NON-OPTIMISED ALGORITHM FOR SANITARY VENTILATION

In this section it will be presented a comparison between two different cases:

- ◆ A case with a non-optimised algorithm for the dilution of pollution in the Folgoso tunnel:

The starting operation is the same as the operation for the optimised algorithm, but when it is necessary to switch off some ventilators progressively, it can only do it by pairs of ventilators.

- ◆ A case with the optimised algorithm for the sanitary ventilation in the Folgoso tunnel:

The manoeuvre for the switching off of the ventilators is done considering every single ventilator.

It is proposed a case of a 10-minutes situation in which the admissible margins of the CO gas are exceeded. Then, it is compared the procedure of both the non-optimised algorithm (algorithm 1) and the optimised algorithm (algorithm 2):

t (min)	level	Ventilators activation (algorithm 2)	Ventilators activation (algorithm 1)
1	1	0	0
2	2	0	0
3	3	1	1
4	4	3	3
5	3	4	4
6	2	4	4
7	1	3	4
8	1	2	2
9	1	1	2
10	1	0	0

Table 2.4.I. – Ventilators activation sequences for algorithms 1 and 2.

The **Table 2.4.II** compares the operation time for the ventilators and the energy expenditure in both cases, taking into account that the single power of each ventilator is 45kW:

	Algorithm 1	Algorithm 2
Operation time (min)	20	18
Energy consumption (kWh)	13,5	15

Table 2.4.II. – Comparison of energy consumption in both cases.

As it can be seen, the difference between both cases means a **10% reduction** in the energy expenditure.



Another factor to assess is the lifetime of the ventilators; as stated previously, the optimised algorithm activates every ventilator depending on their accumulated operation hours, last time operation, etc. This is very positive in order to maintain the integrity of the ventilators.

2.5. EFFICIENCY MEASURES

The measure that may be considered is the implementation of an optimised algorithm to control the sanitary ventilation and activate it only when required is a positive measure to reduce the energy consumption while respecting the standards.

The gist of the optimisation is to respect strictly the admissible margins of pollution and make operate certain ventilators depending on their accumulated working hours, last operation, etc.

This algorithm must be adapted to the tunnel's traffic typology: for unidirectional tunnels the ventilation direction should be in the traffic's direction, while in bidirectional tunnels the most economical solution is to ventilate in the direction with the highest piston effect of the vehicles.

The algorithm should have integrated some conditions to choose the ventilators to activate depending on the pollution's level, their accumulated hours of operation, etc.



3. LIGHTING SYSTEM

The study carried out in Work Package 2 has revealed that the lighting system is generally the most important source of energy expenditure, especially for unidirectional tunnels.

Therefore, once it has been stated the relevance of this system as far as consumption is concerned, it is clear that it is worth analysing with further details.

Normally, the lighting system of a tunnel is divided in two regions:

- ◆ The entrance region, where the daytime luminaires are due to permit the users' eye adapt from the external to the internal conditions.
- ◆ The interior region, where the users' eye have adapted themselves to the inside conditions.

Then, the energy expenditure in this system will be clearly differentiated depending whether it is daytime or not, being less important during night time since the daytime luminaries are switched off.

In road tunnels, the traffic rate and the maximum authorised velocity is established normally in the project elaboration phase for the exploitation phase. This is employed to determine the levels required for the permanent and daytime lighting and remain the same throughout the tunnel's lifetime.

In this aspect, an improvement may be obtained, because the traffic rate is not constant throughout the day and, thus, the lighting level can be adjusted proportionally.

In order to adjust the lighting level continuously depending on the traffic rate, it is mandatory having a lighting system that allows the control of the lighting levels and the luminaries independently, with a quick response to the start order.

If there is a continuous and independent regulation of the luminaries, the energy efficiency can also be increased making the system follow the closest possible the CIE-88 luminance curve.

It is needed the same sort of installation for the continuous adaptation of the lighting level, either by varying with the traffic rate, either following the CIE-88 curve, that's why only one of them will be studied in energy efficiency terms.

Due to the absence of daily traffic distribution for all the year's days for any tunnel, the second option is chosen, which means the adaptation of the lighting levels to the CIE-88's curve.

In order to know which measures can be integrated concerning the lighting system, a real case of a Spanish road tunnel has been analysed and studied.

3.1. MIRAVETE TUNNEL CHARACTERISTICS

In order to carry out a study of a real case, the Miravete Spanish Tunnel has been selected.

In the **Table 3.1.I** the main characteristics of this tunnel are exposed.

MIRAVETE'S TUNNEL		
Situation		
Road	A-5	
Number of tubes	2	
Type of traffic	Unidirectional	
Tubes		
Tubes	Direction Madrid	Direction Badajoz
Longitudinal section		
Length	1.195	1.178
Cross-sectional section		
Maximum height	8,95 m	8,95 m
Authorised gauge	5,65 m	5,65 m
Number of lanes	2	2

Table 3.1.I. –Miravete tunnel characteristics.

Geocontrol has evaluated the state of the current lighting installation.

The results are exposed in the **Table 3.1.II**.

Daytime level	Luminance [cd/m ²]	Requirement	167 cd/m ²
		Measure	71,4 cd/m ²
	luminance [lux]	Requirement	3.907 lux
		Measure	1.824 lux
Cloudy level	Luminance [cd/m ²]	Requirement	84 cd/m ²
		Measure	50,3 cd/m ²
Night time level	Luminance [cd/m ²]	Requirement	4,4 cd/m ²
		Measure	3,1 cd/m ²
	Luminance [lux]	Requirement	82,8 lux
		Measure	66,14 lux

Table 3.1.II. – Comparison between theoretical and real values of lighting.

As it can be seen in the previous figure, there is a relevant difference between the real values and the theoretical lighting values according to the standards.

Therefore, it is necessary to carry out some changes in this system not only because of the optimisation of the energy consumption, but also because of this issue.

The current installation is composed by HPS luminaries.

3.2. REDESIGN OF THE LIGHTING INSTALLATION

The drawing-up of a new document concerning the lighting requirements of road tunnels is underway in Spain. In order to assure that this study's results are adapted to the future requirements, the tunnel's lighting system is re-designed under the new document conditions.

3.2.1. Lighting values

According to the Spanish standards for a road tunnel's lighting system, the steps have been:

◆ Tunnel Classification

The tunnel intensity is classified as Medium (500-1.500) vehicles/hour and lane.

◆ Calculation of the stopping distance

The obtained values are exposed in the following table:

Stopping distance [m]	North portal (Direction Badajoz)	South portal (Direction Madrid)
		140

Table 3.2.1.I. – Stopping distance.

◆ Calculation of L20

L20 is defined as the luminance in the access zone, which is the first luminance of the lighting system to be calculated.

The **Figure 3.2.1.II** shows the methodology that has been followed for this calculation to be done in the particular case of the entrance portal in Madrid's direction.

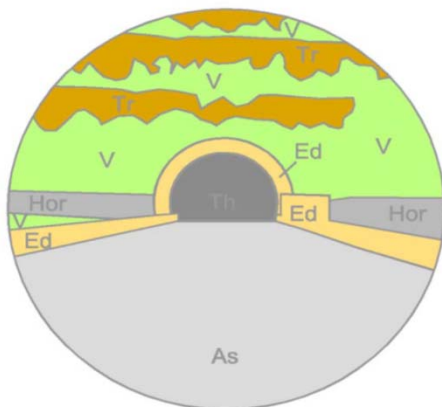
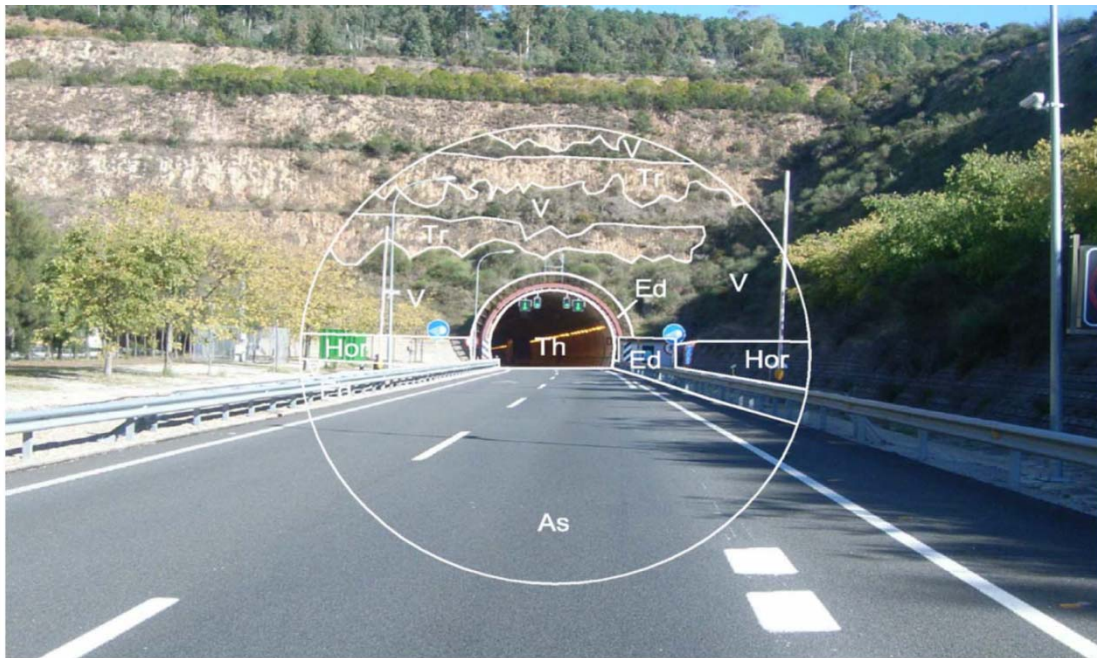

Etiqueta	Descripción	Superficie	%
Th	Túnel	94,5	4,4%
As	Asfalto	872,5	40,9%
Hor	Hormigón	110,7	5,2%
V	Vegetación	618,3	29,0%
Tr	Terreno	271,4	12,7%
Ed	Edificaciones	164,1	7,7%
C	Cielo	0,0	0,0%
TOTALES		2131,4	100,0%

Figure 3.2.1.II. – Photo of the entrance portal in Madrids direction.

The results are:

L20 [cd/m2]	North portal (Direction Badajoz)	South portal (Direction Madrid)
	3 537	3 603

Table 3.2.1.III. – Values of L20

◆ Calculation of the interior lighting

The interior lighting is calculated taking each L20 as the last necessary input.

The **Figure 3.2.1.IV** shows the typical lighting curve for a road tunnel:

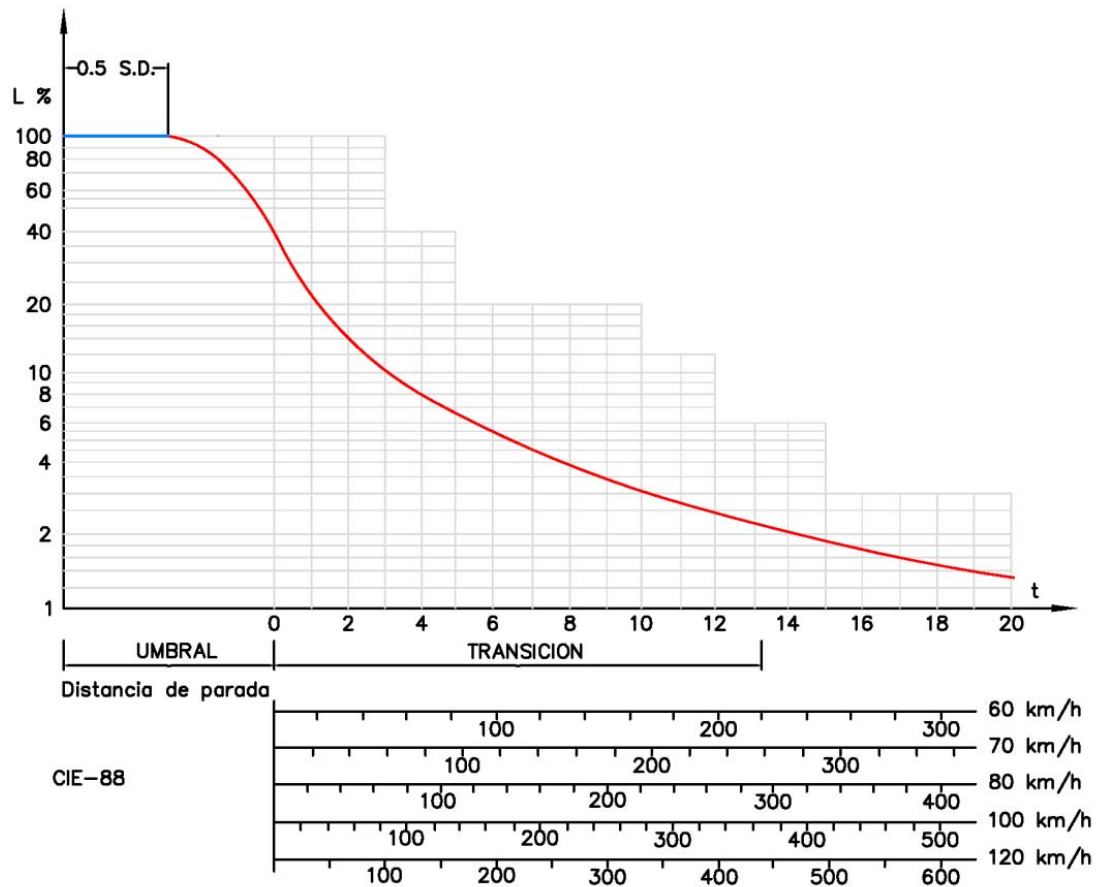

Figure 3.2.1.IV. – Typical curve for the transition of the lighting levels in the interior zone of a tunnel

3.2.2. Luminary's technology

A great improvement in energy consumption may be obtained if the real luminance values in the tunnel followed strictly the CIE's lighting curve. To achieve this aim, it is necessary to check the possible technologies of luminaries to verify which the possibilities in this sense are.

The current technologies are:

- ◆ High Pressure Sodium: there would be no additional benefit, as this is the current technology.
- ◆ Low Pressure Sodium: high efficiency but not commonly used because of their low chromatic reproduction.
- ◆ Metal halide lamps: they'd provide a higher chromatic reproduction with a similar efficiency as in the HPS case. However, the time required for the complete switch on is very long and they have a low capacity for regulation.



- ◆ High Pressure Mercury: not considered because of their low efficiency.
- ◆ Fluorescent tube halophosphate: currently being refurbished in public lighting by triphosphorous.
- ◆ Fluorescent tube triphosphorous: it provides chromatic reproduction, long life time and capacity of regulation with a rapid response, but their low lamps' flow make them not adequate for the daytime lighting and has a lower efficiency.
- ◆ LED: the current equipment provide an efficiency similar to the HPS luminaries, they provide a higher maintenance factor, long life time, very good chromatic reproduction and capacity of regulation with an instantaneous response. To sum up, this is the best choice for the exterior lighting systems (group in which the tunnel's lighting is integrated).

The regulation of the current HPS lighting system is done by switching on groups of luminaries.

However, with an additional cost, the LED luminaries allow the installation of equipment to make a regulation of the electrical flux in each luminary. That means instantaneous regulation of the daytime lighting depending on the instantaneous measure of the L20.

It is also necessary to have equipment in every entrance portal that is capable of doing continuous measures of the luminance in the tunnel's entrance.

The luminancimeters are equipment that are able to do such measures and, therefore, their contribution make possible the continuous regulation of the lighting levels.

3.3. CALCULATION OF THE HOURS OF OPERATION PER MONTH OF EVERY LIGHTING LEVEL

The model created combined with the monthly statistical data about the hours of daylight provided by the website AEMET (www.aemet.es) let us determine the hours of operation for every lighting level. This will be used later to calculate the energy expenditure and the maintenance factor.

For calculating the monthly hours of operation of every lighting level, the following assumption will be considered:

- ◆ The permanent level is switched on from the sunrise to the nightfall.
- ◆ The nocturne level is switched on from the nightfall to the sunrise.

The daytime lighting varies depending of the data registered by the luminancimeter in the entrances of the tunnel. Thus, the hours of operation are weighted depending on the luminance in the access obtained with the steps explained previously and the average monthly sunlight hours provided by AEMET.



$$HF_s = \text{Hours of Operation at 100\% if sunny} = \sum_{day=1}^{month\ end} \sum_{hour=0}^{23} F_a \left(\frac{L(day, hour)}{L_{Maximum}} \right)$$

$$HF_n = \text{Hours of Op. at 100\% if cloudy} = \sum_{day=1}^{month\ end} \sum_{hour=0}^{23} F_a \left(\frac{0.5 * L(day, hour)}{L_{Maximum}} \right)$$

$HD = \text{Number of hours per day}$
 $= \text{accumulation of intervals between sunrise and nightfall}$

$HS = \text{Average number of hours of sun per month according to AEMET}$

$$HF = \text{Hoursof Operation} = \frac{HS * HF_s + (HD - HS) * HF_n}{HD}$$

Where F_a is the function of the activation of the daytime lighting; this represents the percentage of the daytime lighting switched on with respect to the access luminance. This can be the identity function in case of linear regulation with tele-control or a step function in case of regulation through switching on several circuits.

The permanent lighting level is maintained at 100% operating rate during daytime and at 50% operating rate during night time. Thus the weighted number of operation hours working at 100% rate is $(100\% * 12\text{h/day} + 50\% * 12\text{h/day}) * 365 \text{ days/year} = 6.570 \text{ hours per year}$.

The results obtained particularised for every month at the North entrance are shown in the **Table 3.3.I**.



MONTH	HS	HD	HN	HF
January	160	279	465	511,5
February	180	306	366	489
Mars	240	359	386	552
April	236	390	330	555
May	285	447	297	595,5
Jun	329	450	270	585
July	370	465	279	604,5
August	344	409	335	576,5
September	257	370	350	545
October	209	341	402	542
November	158	284	436	502
December	123	279	465	511,5
ANNUAL	2.890	4.379	4.381	6.570

Table 3.3.I. – Operation hours for every lighting level.

For the daytime lighting, the **Table 3.3.II** distinguishes the results for the North entrance when a two-level step daytime lighting (sunny and cloudy level) or a linear regulation (proportional to the luminance at the entrance) is considered:



	Stepped regulation			Linear regulation		
	HF _s	HF _n	HF	HF _s	HF _n	HF
January						
February	118	96	109	70	35	55
Mars	141	109	128	93	46	73
April	241	147	210	154	77	129
May	285	161	236	204	102	164
Jun	321	188	273	252	126	206
July	317	186	282	261	130	226
August	327	192	300	261	131	235
September	309	174	288	228	114	210
October	253	151	222	169	85	143
November	186	129	164	119	59	96
December	119	98	110	75	37	58
ANUAL	2730	1716	2417	1946	973	1639

Table 3.3.II. – Operation hours of with step or linear regulation.

As it can be seen in the **Table 3.3.II**, the number of operation hours decreases dramatically from 2.417 to 1.639 when it is considered a linear regulation, which means a 32% reduction in annual energy consumption.

The results for the South entrance are not shown since they are quite similar to the ones for the North entrance. The results are 6.570 annual hours of operation for the permanent lighting, 2,452 hours for the daytime lighting with step regulation and 1.712 hours for daytime lighting with linear regulation.

3.4. OTHER POSSIBLE EQUIPMENT TO OPTIMISE THE LIGHTING OPERATION

As well as the progressive adaptation of the lighting system to the CIE's lighting curve, another improvement can be achieved through the activation of the night time lighting only when it is required.

For this to be done, it would be necessary to install intrusive detectors on the road at a certain distance, in such a way that:

- ◆ When no vehicles approach to the tunnel, the night time lighting is switched off.
- ◆ When a vehicle is approaching to the tunnel, the night time lighting gets activated.

This can only be done with the LED technology, since the activation time is much faster in this technology than in other, such as HPS luminaries.

The current installation of the Miravete Tunnel night time lighting is composed by 96 150W – single power luminaries. Let's suppose that this improvement has been integrated in the tunnel's operation.

Then for a day in which vehicles are passing through the tunnel half of the time and assuming that night time starts at 22.00h and finishes at 6.00h, the comparison between having and not having this improvement would be:

- ◆ No improvement integrated: the energy consumption is 115,2 kWh
- ◆ Improvement integrated: the energy consumption is 57,5 kWh.

This result means that the savings if the improvement was integrated would reach a 50% of the current consumption.

To implement this measure is necessary to have a traffic gauging station:

This equipment is due to detect the transit of a vehicle and will send a signal to the control system to get the night time luminaries activated.



Figure 3.4.I. – Example of traffic gauging station.



3.5. EFFICIENCY MEASURES

The measures due to be implemented are the following ones:

◆ Flux regulation and LED technology

Setting a power regulation of the luminaries depending on the external L20 is a good improvement as far as energy expenditure is concerned. This way, the lighting levels inside the tunnel are adapted strictly to the requirements fixed by the standards.

A LED luminary offers the possibility of instantaneous regulation, which allows a good and rapid adaptation to the CIE's lighting curve. However, other kind of luminaries such as HPS ones, cannot offer a single power reduction change, but this is made by groups of luminaries; this doesn't permit to adapt to the CIE's lighting curve as well as LED luminaries are able to do.

Therefore, a relevant saving can be obtained through the lighting system's regulation through the continuous regulation of this system.

◆ Night time operation depending on the presence of vehicles:

Another important step forward can be done with night time lighting operation's control.

A loop can be installed in every access of a road tunnel, in such a way that the night time luminaries only get activated when a vehicle is approaching the tunnel.

Therefore, the energy consumption decreases dramatically, as this system is activated just when it is mandatory.

◆ Capturing and transportation of the external lighting

The daily lighting consumes electrical energy to convert it into lighting energy when most solar energy is available in the exterior of the tunnel; therefore it is evident that if the solar energy is captured and transported to the interior of the tunnel, the lighting consumption could be reduced.

Some similar solutions have been put in practice in the architecture domain for buildings' lighting, but these solutions are not foreseen for road tunnels, since the lighting levels in buildings are strongly lower than those required in the case of a tunnel.

This solution will need the development of a specific solution for tunnels in the framework of the WP4.



4. SELF – GENERATION OF ENERGY

The study of self – generation of energy will be focused on three branches:

- ◆ Wind energy due to the piston effect of the vehicles.
- ◆ Energy from the sun: the photovoltaic energy will be selected as a way of energy generation.
- ◆ Hydro electrical energy.

In the following sections a detailed analysis is presented for every branch.

4.1. WIND ENERGY

It is well known that the effect of the transit of vehicles through a tunnel generates a piston effect of the vehicles in their direction. In unidirectional tunnels this effect is quite relevant, while in bidirectional tunnels it is less notorious as the vehicles pass in both directions.

The piston effect of the vehicles created by the vehicles' mass constitutes a potential source of wind energy that can be extracted and transformed into electrical energy.

The aim of the present study is to quantify, through a real case, in which measure the potential of the ventilation in a road tunnel can be profitable for self – generation purposes.

4.1.1. BIELSA TUNNEL CHARACTERISTICS

In order to quantify the wind potential, a bidirectional tunnel has been selected, which is a more complex case than a unidirectional tunnel. A comparison between unidirectional and bidirectional tunnels will be provided at the end of the section.

The Bielsa Tunnel has been selected for this study. The **Table 4.1.1.I** shows the main characteristics of this tunnel:

BIELSA TUNNEL		
Situation		
Road	A-38 (Spanish side) and RD-173 (French side)	
PK entrance portal	0+000	
PK exit portal	3+070	
Number of tubes	1	
Type of traffic	Bidirectional	
Tube		
Direction	Bielsa	Aragnouet
Longitudinal section		
Length	3.070m	
Maximum slope	5,35%	
Cross-sectional section	35,6m ²	
Maximum height	6m	
Authorised gauge	4,3m	
Tunnel's width	7,5m	
Number of lanes	2	

Table 4.1.1.I. – Bielsa Tunnel's characteristics.

Five anemometers have been employed to carry out the study of ventilation in the Bielsa Tunnel. The **Table 4.1.1.II** shows the placements of those anemometers:

Anemometers situation	
Anemometer	PK
1	0+127
2	1+092
3	1+625
4	2+330
5	2+920

Table 4.1.1.II. – Placement of the anemometers.

The equipment have been placed with an inter spacing quite similar, in order to measure the airflow velocity in five representative cross – sectional areas of the tunnel. The **Figure 4.1.1.III** presents a cross – sectional area for this tunnel:



Figure 4.1.1.III. – Cross – sectional area of the Bielsa Tunnel.

The model of the anemometer is VM 400 S-AI from the manufacturer Sick. The equipment has been placed and stuck on the side walls to measure the airflow velocity in these five sections.

Due to the particular placement of the anemometers, the obtained measure doesn't correspond to the real value in the middle of the cross – sectional area, but a correction factor must be applied.

The correction factor to apply to the anemometers on the side walls depends on several parameters, such as the tunnel's geometry, the position of the anemometer and the velocity itself inside the tunnel.

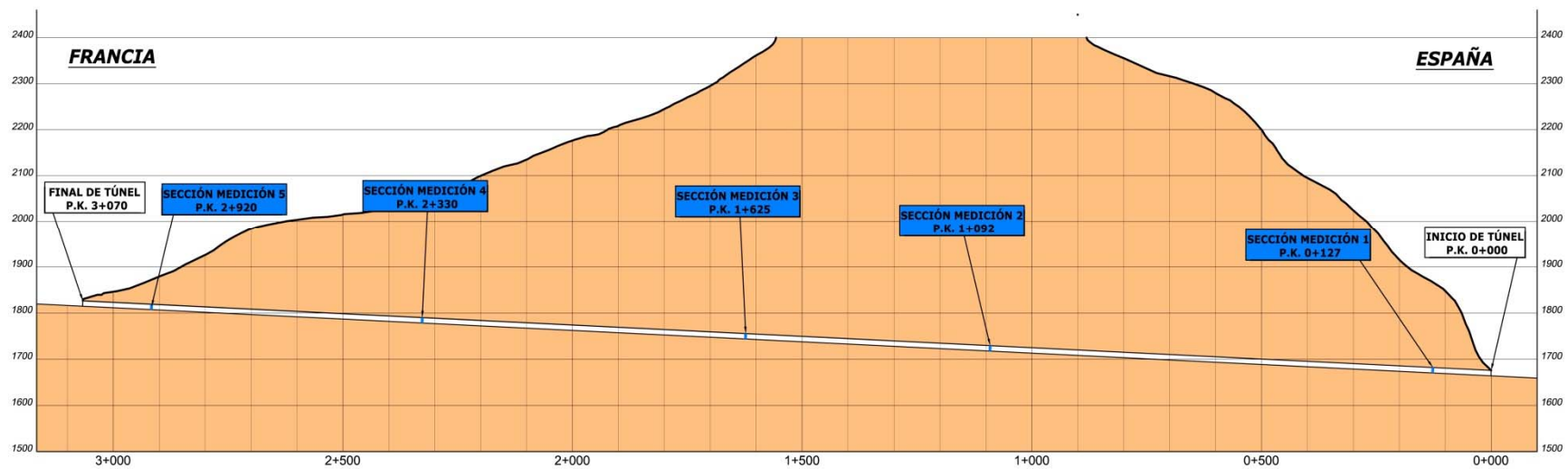

Figure 4.1.1.IV. – Situation of the anemometers in the Bielsa Tunnel in a longitudinal section.

According to the anemometers manuals, specific bibliography for airflow measuring in mines (*Mine Ventilation*, Hartman et al.) and specific articles ("*Ensayos para la verificación de sistemas de ventilación*", Ignacio del Rey, ETSIIM) the correction factor has been taken as 1,15.

The **Figure 4.1.1.V** shows the installed anemometer, with all its components:

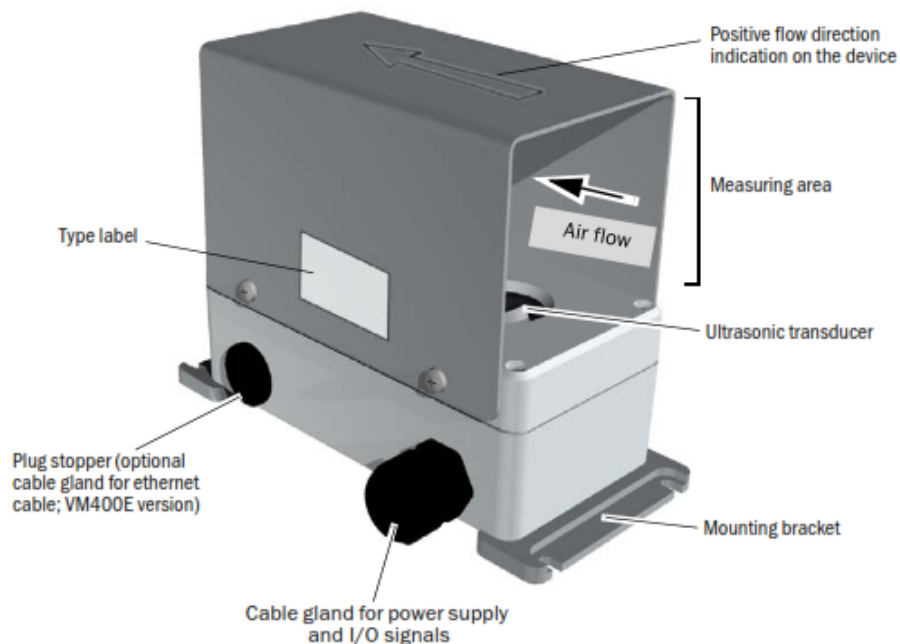

Figure 4.1.1.V. – Characteristics of the anemometer installed in the Bielsa Tunnel

The metallic part is the measuring zone. In the outer face of it, it is indicated the sense of measuring to be considered as positive. Within the space for the measure, there are two ultrasonic transducers, in charge of carrying out the measures.

The **Photography 4.1.1.VI** shows one of the anemometers installed in the side walls of the tunnel:



Photography 4.1.1.VI. – Anemometer installed in the Bielsa Tunnel.

4.1.2. Measuring campaign

The duration of the measuring campaign has lasted a year, from November 2013 to October 2014. During this time, it has been collected the data of the natural ventilation with a 1-minute frequency between two consecutive measures.

The data have been extracted from the anemometers with a frequency of 2-4 weeks. The control unit of every anemometer creates a txt file, which can be converted into an excel format for its subsequent treatment.

The data that have been obtained cover both the daytime and the night time. It has to be underlines that, during the day, the data are influenced by the passing through of the vehicles, situation that doesn't take place during the night.

It shouldn't be forgotten that the daily average traffic rate is 997 veh. per day, with just a 3% of Heavy Goods Vehicles. Then, the piston effect of the vehicles is not considered to have great influence in the Bielsa Tunnel and the magnitude of the airflow may be attributed overall to the atmospheric phenomenon.

The reason why 5 anemometers have been used is in order to work with more realistic values, as the average value already takes into account every single measure.

Once all the filters have been put in place, the next step forward has consisted in statistical treatment of the remaining data. In the **Table 4.1.2.I** the results after the filtering are exposed.

The reference value for the velocity is 3,05m/s, which corresponds with the minimum airflow velocity for an aero generator to start operating.

Due to a failure in the anemometers, it hasn't been possible to treat the data concerning the month of February-14.

Month	Daytime		Night time	
	Percentile	% useful time	Percentile	% useful time
nov-13	76	24,00%	75,6	24,40%
dec-13	100	0,00%	100	0,00%
jan-14	80,5	19,50%	84,8	15,20%
feb-14	-	-	-	-
mar-14	95,5	4,50%	80,2	19,80%
apr-14	99,6	0,40%	99,3	0,70%
may-14	92	8,00%	93,7	6,30%
jun-14	100	0,00%	99,8	0,20%
Jul-14	99,8	0,20%	99,4	0,60%
aug-14	95,6	4,40%	99,1	0,90%
sep-14	100	0,00%	100	0,00%
oct-14	99,5	0,50%	97,6	2,40%

Table 4.1.2.I. – Statistical results of the filtered data

After evaluating the results in **Table 4.1.2.I**, we conclude for this particular tunnel that:

- ◆ The Bielsa Tunnel's wind potential is rather low, reaching its maximum value the month of November-13 during night time, with a 24,4% of the time turning out useful.
- ◆ The fact of having a low traffic rate is strongly related to the low potential to extract wind energy during the tunnel's exploitation.
- ◆ This studied case is a bidirectional tunnel, in which the piston effect of the vehicles may have a random distribution because of having vehicles flow in both directions. This is not good for the purpose of taking advantage of the piston effect of the vehicles, due to its continuous variations throughout a day.
- ◆ However, for unidirectional tunnels it may be expected to have better results in wind potential terms, because the piston effect of the vehicles remains always in the direction of the traffic.

4.1.3. Efficiency measures

The proposed measure to take advantage of the wind potential is the **installation of a wind turbine**. The wind energy of a tunnel's airflow can be captured and transformed into electrical energy by the installation of this equipment.

It has to be calculated for every tunnel the expected percentage of time turning out useful for this purpose. There are some wind turbines that may be adapted to capture wind energy in a tunnel and then turn it into electrical energy.

Unfortunately, there is no real tunnel in which this kind of installation has been put in place yet.

In order to increase the efficiency, specific equipment should be designed for the particular case of a road tunnel. However, for the initial assessment of the technical viability, a commercial model of aero generator can be selected.

The selected model is the Air 40 / Air Breeze aero generator, from the American manufacturer Primus Wind Power.

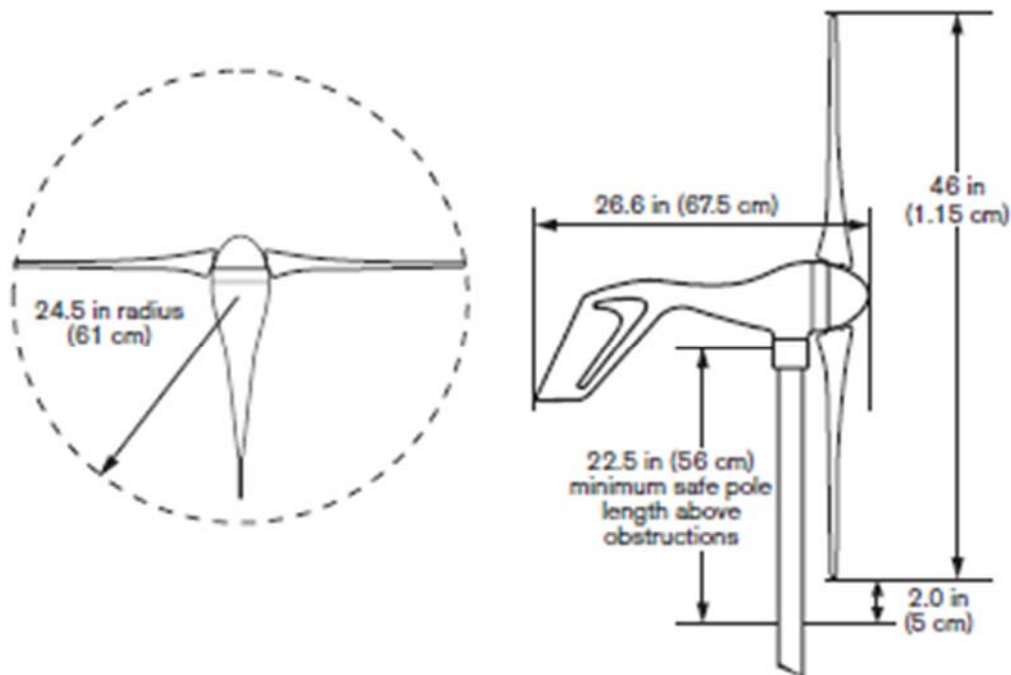

Figure 4.1.3.I. – Air 40 / Air Breeze aero generator.

The main characteristics of this equipment are:

Specifications and characteristics of Air Breeze and Air 40	
Energy	160 watts @ 28 mph / 12.5 m/s wind speed
Rotor Diameter	1.17 m (46 in)
Weight	6 kg (13 lb)
Start-up Wind Speed	3.1 m/s (7 mph)
Voltage	12, 24, 48 VDC
Maximum Wind Speed	110 mph
Kilowatt Hours/month	38 kWh/month @ 12 mph / 5.4 m/s avg. wind speed
Operating Temperature Range	AIR Breeze and AIR 40 are certified under IEC requirements applying to the temperature range 14°F (-10°C) to 104°F (40°C). AIR 40 is CSA certified.

Table 4.1.3.II. – Characteristics of the Air Breeze / Air 40 aero generator.

This aero generator would be installed fixed to the top of the tunnel’s vault.

The **Figure 4.1.3.III** shows the output power that the turbine can provide, depending on the airflow’s velocity:

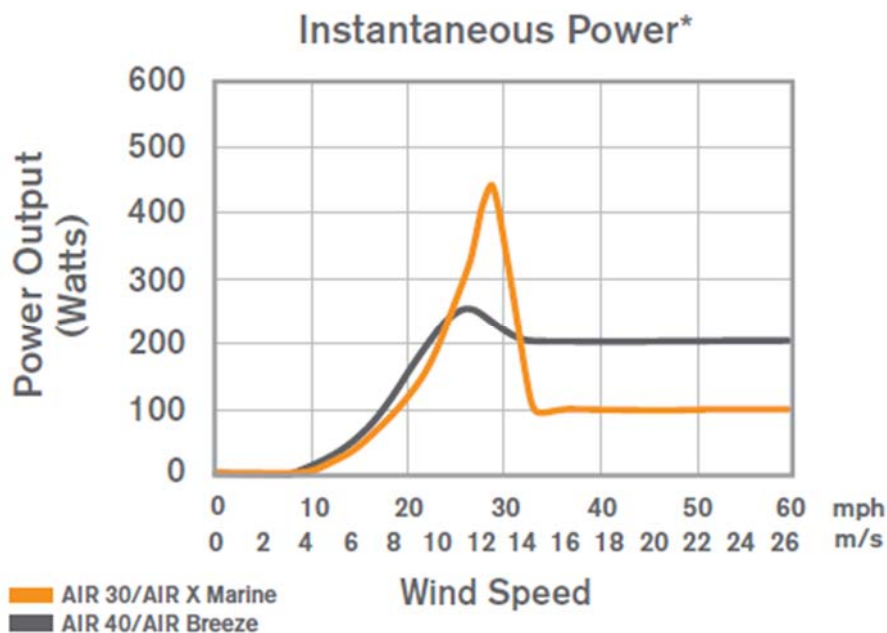

Figure 4.1.3.III. – Power output depending on the airflow’s velocity.

The **Figure 4.1.3.IV** shows the monthly average energy generation depending on the airflow’s velocity:

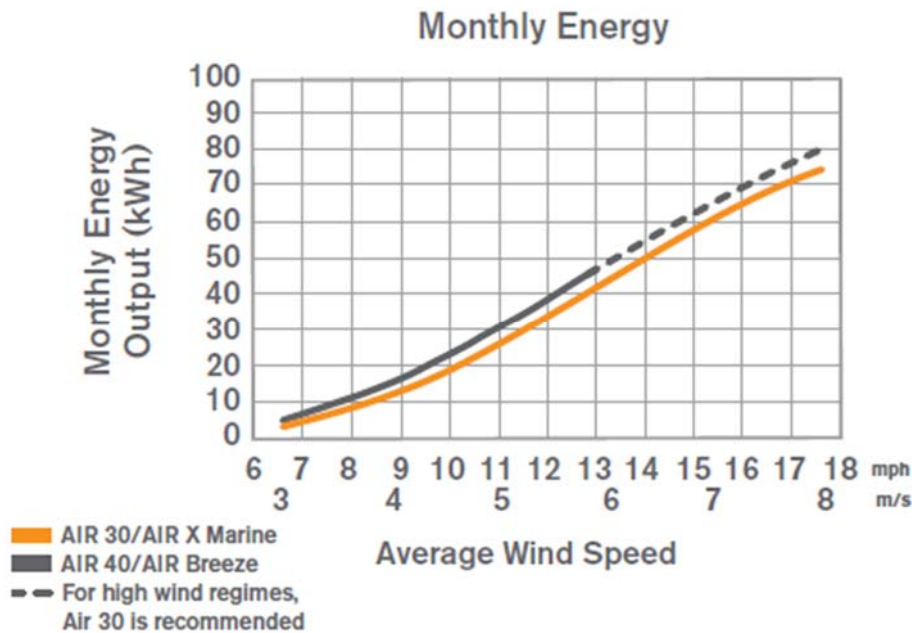

Figure 4.1.3.IV. – Power output depending on the airflow's velocity.

The particular case of the Air 40 aero generator assures a 38 kWh per month power generation for an average airflow velocity of 5,4m/s. This amount of energy may be used to cover the needs of installations with low demands.

Since the start up velocity for this device is 3,1m/s, it is feasible to generate energy in a relevant part of the time. Besides, it is important to remark that this equipment may suit well the case of a unidirectional tunnel, especially if the traffic rate is important.

Furthermore, another factor to take into account is the size of the wind turbine and the available space for its placement. The Air 40 aero generator's rotor diameter is 1,15m, which may be suitable for its placement in a tunnel's vault.

Finally, it would be recommendable to effectuate a 1-year ventilation measuring campaign, which permits to compare energy generation with energy demands with real data and design correctly this installation.

4.2. SUN'S ENERGY

In this section it will be explained the current possibilities to capture the energy from the sun and take advantage to cover energy demands from a road tunnel.

The Sun constitutes an endless energy source, but the energy released in the Earth's surface depends on several factors:

- ◆ Effect of the atmosphere: The atmosphere causes a reduction of the extraterrestrial solar input by about 30 per cent on a very clear day to nearly 90 percent on a very cloudy day.
- ◆ Hours of Sun per day: this depends on several parameters (day of the year, latitude angle, etc).

Depending on these factors, the sun's potential may be more or less profitable for self – generation purposes.

There are currently different technologies that allow taking advantage of the sun's energy, among which the most representative are:

- ◆ Large scale technology: cylindrical parabolic collectors, photovoltaic parks.
- ◆ Small scale technology: photovoltaic solar cells, solar water collectors.

Since the most extended technology to cover low demand needs is the photovoltaic energy, this is the kind of technology on which this study will be focused.

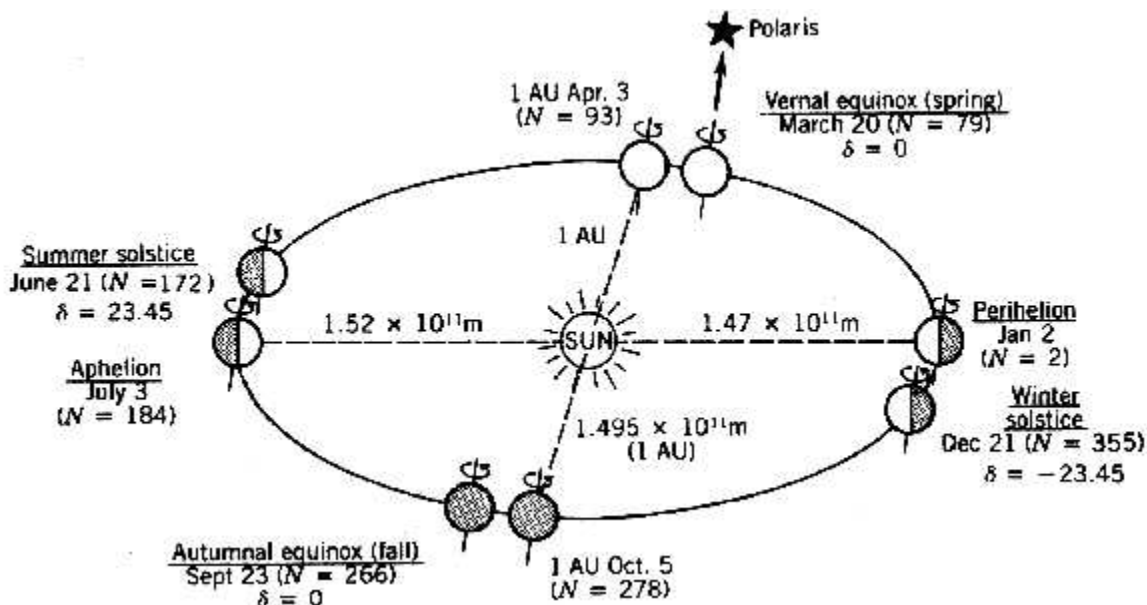

Figure 4.2.I. – Earth's trajectory during a year

The present study will seek to determine:

- ◆ In which measure the energy collected from the sun is useful for a road tunnel's demands.



- ◆ The use that can be done to the energy that has been generated.
- ◆ Equipment that can be used for this purpose.

4.2.1. Miravete Tunnel Study

In order to quantify the sun’s potential for self – generation, the Miravete tunnel has been selected (this tunnel has already been described).

The proposal consists on the installation of a group of photovoltaic solar panels, which will provide the necessary energy to cover the needs of the Control Centre. This system will be implanted for self – consumption purposes, not for selling the energy to the electrical companies of the zone.

During daytime periods, the user employs the energy generated in its own installation and, in case of need to increment the amount of energy, the electricity company will be due to cover this need.

The Control Centre has South orientation, which is quite appropriate for the installation of photovoltaic solar panels. Thus, two possibilities have been studied:

- ◆ Option 1: installation over the roof surface of the Centre.
- ◆ Option 2. Installation in an annexe area.

	Advantages	Disadvantages
Option 1: over the roof surface	Closer to the electrical charges	Surface theoretically non-transitable. Danger of harming water proofing.
Option 2: in an annexe area	Further of the electrical charges. Better access for maintenance.	It requires civil work to adapt the surface. It is recommended to set a fence to avoid people to enter the zone.

Table 4.2.1.I. – Options for the placement of the photovoltaic installation

The installation consists of 6 modules of 230 Wp connected to an inverter of 2,5 kW, which transforms the generated DC current into AC current able to be used. The inverter will have a communication card with direct connection with the Control Centre’s servers to report about the state of the installation, the generated energy, and the alarms due to failures.

It has been done a study for the installation’s viability, with an estimation of the electrical charges that would be covered by the installation and the generation capacity of the system. As it will be shown later in this section, it is expected that the demander power will be lower than the production capacity for all the year’s months. This way, this may be the first Control Centre to be powered by itself in Spain.



The domestic appliances are taken into account in order to estimate their daily consumption, as well as with the Centre's lighting:

Domestic appliances consumption per day			
Device	Hours	Energy	Total
TV	3	70W	210 Wh
Fridge	8	195W	1.560 Wh
Micro waves	0.8	800W	640 Wh
TOTAL			2.410 Wh/day

Lighting consumption per day				
Type	Nº	Hours	Energy	Total
Fluorescent lamp	2	5	11W	110 Wh
Incandescent lamp	2	5	60W	600 Wh
Fluorescent tube	2	5	30W	300 Wh
TOTAL				1.010 Wh/day

The theoretical total energy consumption per day reaches the value of 3.420 Wh/day. The global efficiency of the system is 81,9%, which permits to calculate the real demands:

Total daily real energy consumption = **4.175,82 Wh/day**

The input parameters are used to calculate the number and characteristics of the system components:

Number	Elements
6	Module type BIOENERGY BASIC 235 POLICRISTALINO
1	Regulator type MORNINGSTAR TRISTAR 60A PWM
12	Battery type ECOSAFE TZS-22 Tubular plate
1	Inverter type - VICTRON PHOENIX 48/3000

Table 4.2.1.II. – Options for the placement of the photovoltaic installation.

Taking into account the consumption elements selected and the installation components calculated, we obtain the comparison of energy consumption and generation for a year's period:

The **Figure 4.2.1.III** presents the comparison between the expected demand and production of energy for the particular case studied.

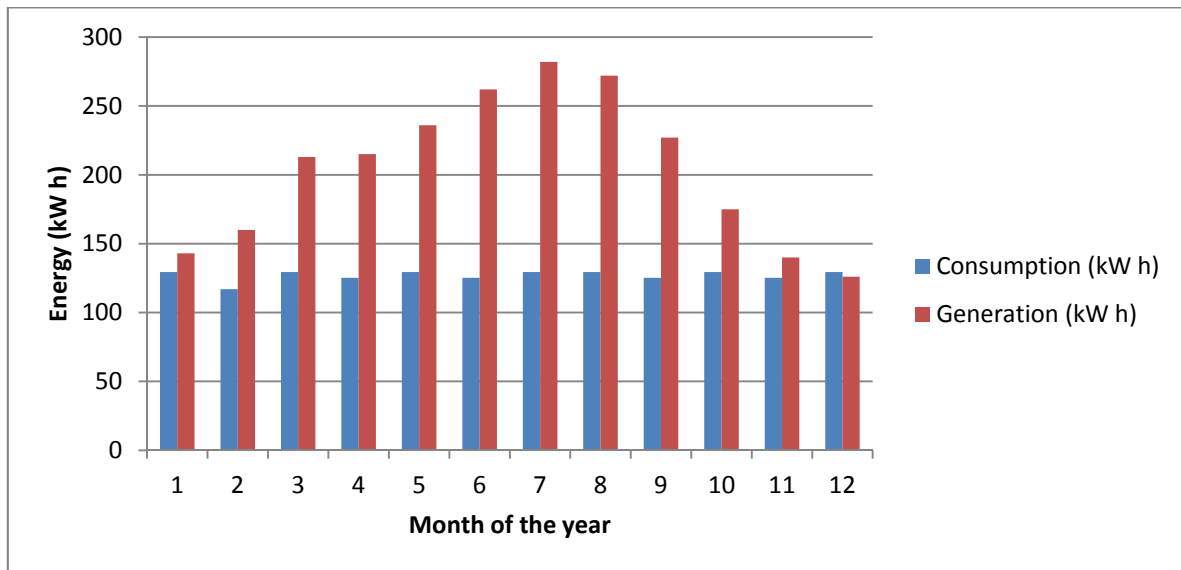

Figure 4.2.1.III. – Comparison between Consumption and Generation

The most relevant information extracted from the **Figure 4.2.1.III** is:

- ◆ Total year's consumption: 1.524 kW h.
- ◆ Total year's production: 2 451 kW h.
- ◆ Total kg CO₂ avoided per year: 1.328 kg.

The self – generation through photovoltaic panels is possible for any kind of tunnels, since the output energy must be theoretically destined to installations with low demands (Control Centre's appliances or lighting).

This way of generation is not constant throughout a year, but it depends on the epoch, being more fruitful during the summer and less important during the winter. Therefore, if it's desired to cover the Control Centre's needs, the design should take into account the worst cases of demand and generation.

4.2.2. Efficiency measures

The proposal consists in the installation of a system of photovoltaic panels for covering low demand needs.

The energy generation can be enough to cover the consumption of the appliances and the lighting system of the Control Centre.

In order to make the study more extensive, it is recommended to study the possible contribution of this energy generation to cover other demands, such as the lighting system of the transformation centres or others.



This measure would be a good step forward to approach the tunnel's exploitation to the sustainability.

Anyway, this measure cannot be considered as a specific one for energy efficiency for tunnels, since it has been put in practice for decades in other domains with the same or similar equipment. Therefore, there is no need for the scope of the study to get further and analyse the installation of solar panels.

4.3. HYDROELECTRIC ENERGY

In this section it will be analysed the possibility of capturing energy from a tunnel's drainage water flow.

The potential and kinetic energy of a water flow are due to the height and to the velocity of the flow. Therefore, the equipment to install to capture this energy should be prepared for a range of velocity flow and height, since this may strongly vary depending on the tunnel.

Currently in the global market there are several possibilities to install for this kind of purpose. Depending on the power desired to extract from the water flows, several models of turbines may be chosen.

A turbine transforms the potential energy of the water flow into mechanical energy, which is also used to generate electrical energy, by connecting the turbine's axle to an electricity generator.

The electrical power that can be obtained depends on the quantity of water channelled to the turbine, on the pressure of the water and on the electrical efficiency of the generator. The water that goes out of the turbine is released to the river at a lower level than before entering the turbine.

In the **Figure 4.3.1** the most representative models of turbines can be seen:

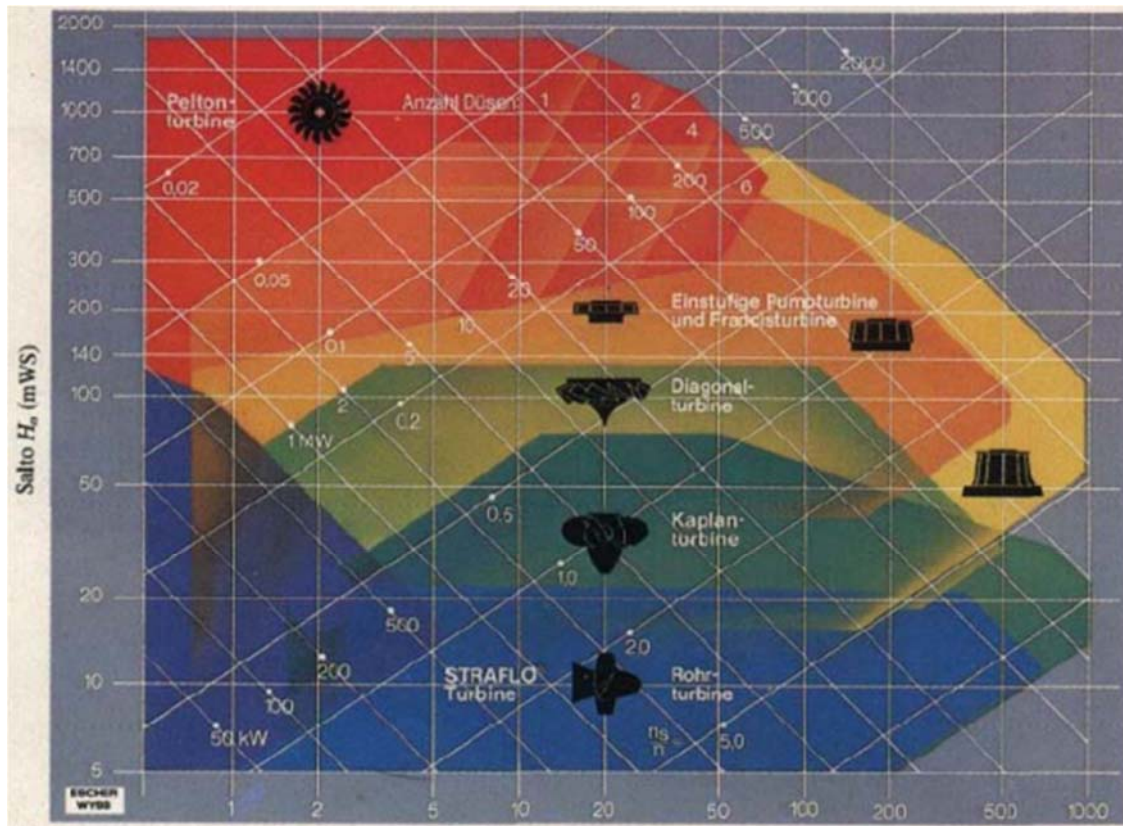

Figure 4.3.I. – Different models of classical turbines.

It is possible to extract some conclusions from the **Figure 4.3.I**:

- ◆ For high heights and low water flows, the Pelton turbines are adequate to generate energy.
- ◆ For medium heights and high water flows, the Francis turbines are adequate to generate energy.
- ◆ For low heights and high water flows, the Kaplan turbines are adequate to generate energy.

Taking into account that the expected water flow from a tunnel's drainage and the height are rather low, none of those models suit the needs of this study.

Therefore, it is necessary to seek other models designed for lower energy generations. The equipment that may be used for this purpose are the micro turbines and pico turbines.

- ◆ Micro turbines: They suit to energy generation needs demands than 100 kW. For its operation, they need a height in the range (5-30) m and a water flow in the range of (35-500)l/s.



- ◆ Pico turbines: The appearance is the same as in the case of micro turbines, but they operate with lower power. They allow using the hydraulic energy from channels or conductions to provide energy to autonomous installations with energy needs less than 5 kW.

They are capable of working with a very low height and very low water flows. The minimum height they need to generate energy is 1,5m and the water flow varies in the range (35-130) l/s. If the available height higher, from 3-15m, then the required water flow is around 5l/s.

Both the micro turbines and the pico turbines can generate AC current with 220V or DC current with 12 or 24V.

The wide variety of available equipment permits to assure the technical feasibility for the installation of turbines taking advantage of a tunnel's drainage.

4.3.1. Efficiency measures

The proposal for the energy efficiency is based on the installation of hydraulic turbines in the tunnels' drainage. Nevertheless, as no data is available concerning neither the water flow, nor the height or the outlet pressure of the tunnels' drainage system, it cannot be determined a more adequate equipment for this purpose.

Furthermore, no data is available about the yearly variation of the water flow or the outlet pressure of the tunnels' drainage; therefore, no assessment can be realised in terms of economic feasibility for the proposed measure.

In order to determine the adequate equipment and the economic feasibility of the proposal, in the framework of the WP4, some measuring equipment for the drainage parameters will be installed in one of the tunnels aimed to be studied.



5. CONCLUSIONS

The following conclusions can be extracted from this study:

- ◆ It is essential to focus the efficiency measures to undertake on those systems where there are real possibilities of reducing the energy expenditure. For unidirectional tunnels, the main source of expenditure is the lighting system, while for bidirectional tunnels, both the lighting and the ventilation system are the main sources of consumption.
- ◆ As far as the sanitary ventilation is concerned, an optimised algorithm may be a key factor in order to activate this system only when it is required. Therefore, it is vital that the algorithm is adapted to the type of traffic (bidirectional or unidirectional).
- ◆ Unless there are other stronger restrictions, the option that reduces the energy expenditure is to ventilate in the traffic's direction for unidirectional tunnels and in the direction where the piston effect of the vehicles is more notorious for bidirectional tunnels.
- ◆ The algorithm should optimise the number of ventilators and their order of activation to achieve the aim with the lowest energy consumption.
- ◆ If we focus on the lighting system, a great improvement can be achieved by a regulation that adapts the lighting levels in the tunnel in real time to reproduce the CIE's lighting curve.
- ◆ For this purpose, the LED luminaries are the most adequate equipment, since other technologies do not permit this kind of regulation. Also, it is necessary to have measuring equipment for external lighting conditions, like luminancimeters, which can collect in real time the value of the L20.
- ◆ Capturing and transportation of external lighting to the interior can reduce significantly the energy consumption of road tunnels with a medium length, where the daytime lighting has a relevant percentage among all the consumption sources. Due to the high lighting requirements in road tunnels, the solutions that have been employed so far in the architecture domain are not considered as valid and new solutions must be designed.
- ◆ Self – generation of energy in a road tunnel is possible: the main possibilities are the wind energy, the photovoltaic energy and the hydro electrical energy.
- ◆ The self – generation through wind energy seems to be more adequate for unidirectional tunnels with a high traffic rate, since the airflow's velocity tends to be higher than in bidirectional tunnels or tunnels with low traffic rates.



- ◆ The self – generation through photovoltaic solar panels is possible for all kind of tunnels, but the output energy must be generated to cover equipment with low energy needs.
- ◆ Hydro electrical energy: despite it is technically possible, its relevance cannot still be analysed till more precise data is available.



Statens vegvesen
Vegdirektoratet
Publikasjonsekspedisjonen
Postboks 8142 Dep 0033 OSLO
Tlf: (+47 915) 02030
publvd@vegvesen.no

ISSN: 1893-1162

vegvesen.no

Trygt fram sammen